

## 2JL10

868 MHz ISM Surface Mount

### Key Features

#### 868 MHz ISM

- 863-870 MHz

Surface Mount

Easy to Integrate

Compact Size

Ceramic Material

Ground Plane Dependent

Dimensions 5 x 3 x 0.5 mm



## 1. Antenna and electrical specifications

Parameters	868 MHz ISM Antenna
<b>Standards</b>	ZigBee, ISM, SigFox, LoRa
<b>Band (MHz)</b>	868
<b>Frequency (MHz)</b>	863-870
<b>Return Loss (dB)</b>	~-14.4
<b>VSWR</b>	~1.6:1
<b>Efficiency (%)</b>	~43.7
<b>Peak Gain (dBi)</b>	~1.0
<b>Average Gain (dB)</b>	~-3.7
<b>Impedance (Ohm)</b>	50
<b>Polarisation</b>	Linear
<b>Radiation Pattern</b>	Omni-Directional
<b>Max. Input Power (W)</b>	25

### Antenna Measurement Conditions:

Mounted on ground plane of 80 x 40 mm

Measured in Certified CTIA 3D Anechoic Chamber

## 2. Mechanical and environmental specifications

Specifications	2JL10
<b>Mounting Type</b>	Surface Mount
<b>Dimensions (mm)</b>	5 x 3 x 0.5
<b>Material</b>	Ceramic
<b>Operating Temperature (C)</b>	-40 to +85
<b>Storage Temperature (C)</b>	-40 to +85
<b>Substance Compliance</b>	RoHS

### 3. Antenna parameters

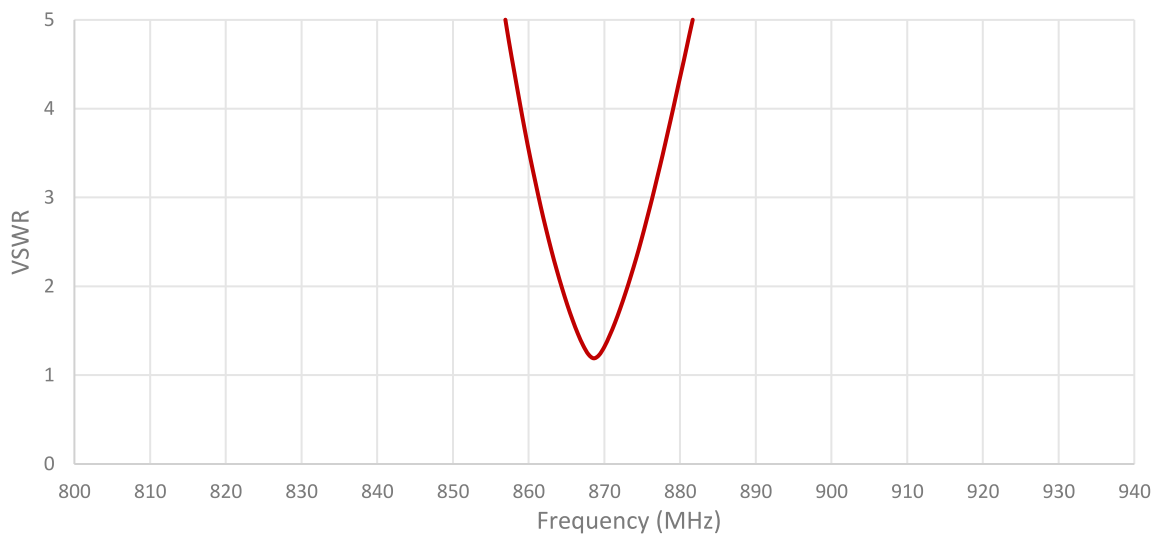
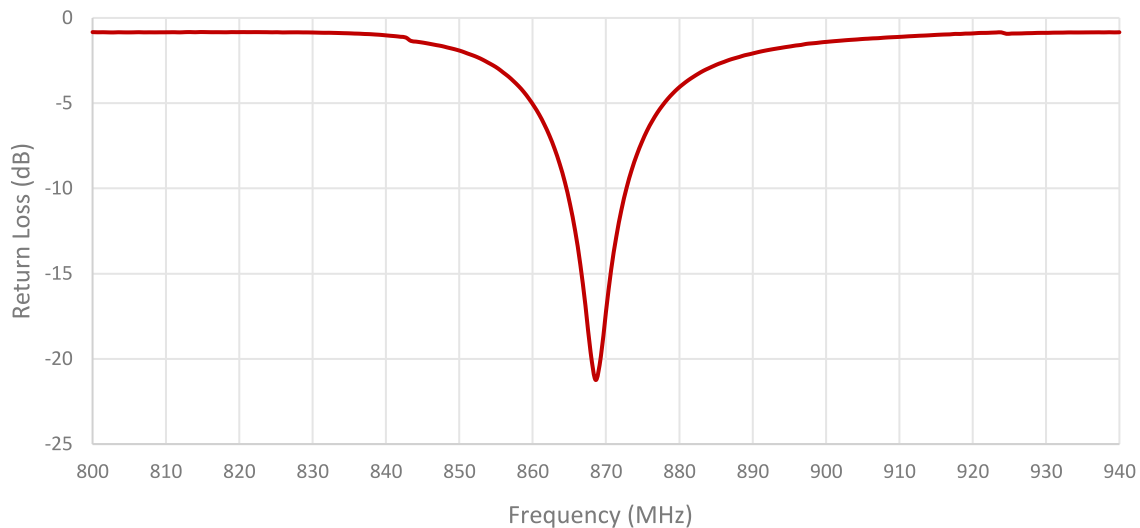

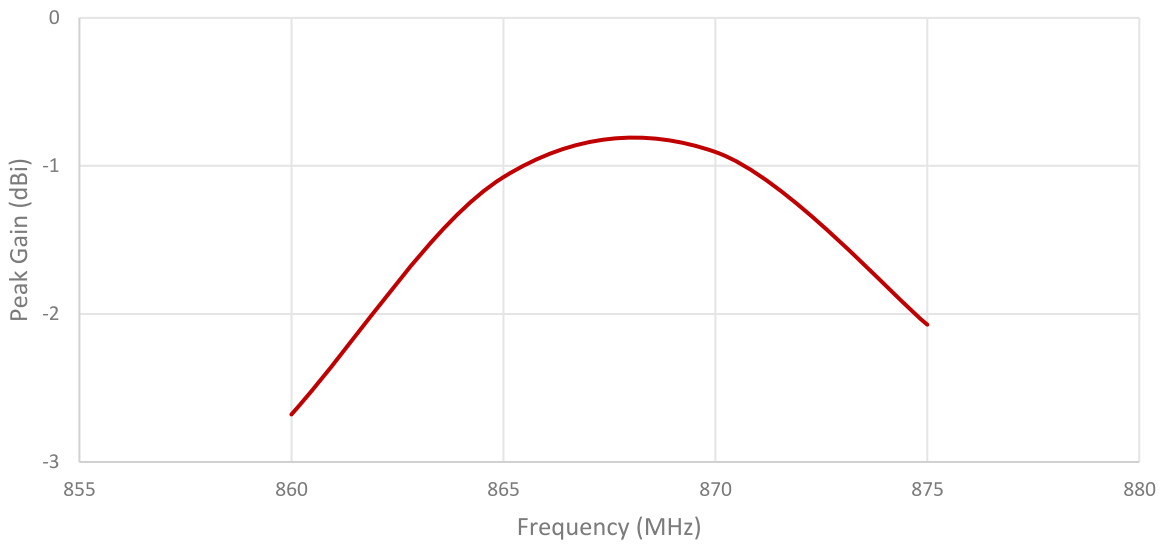
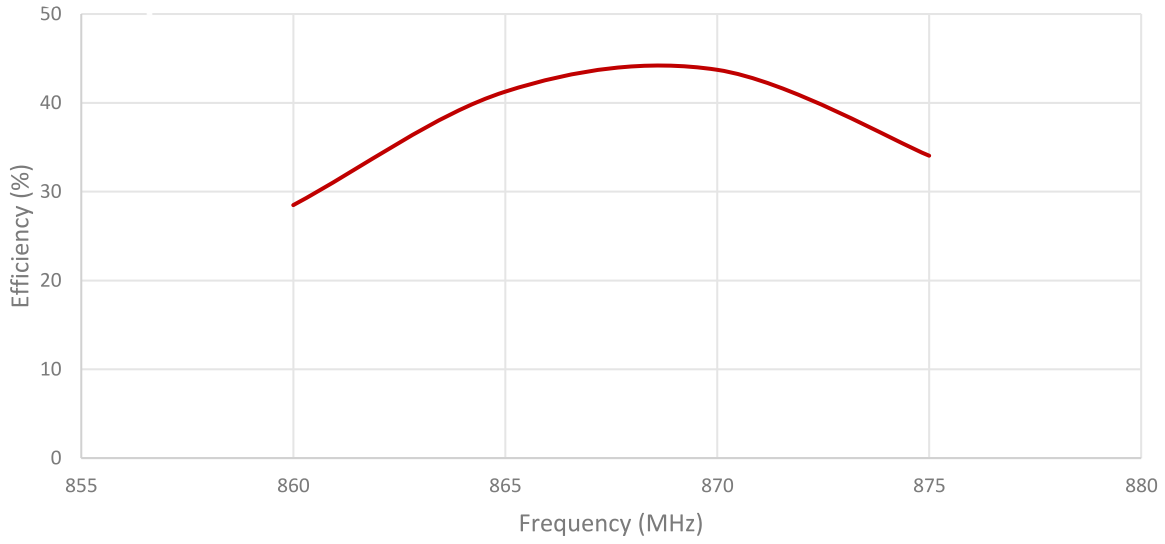

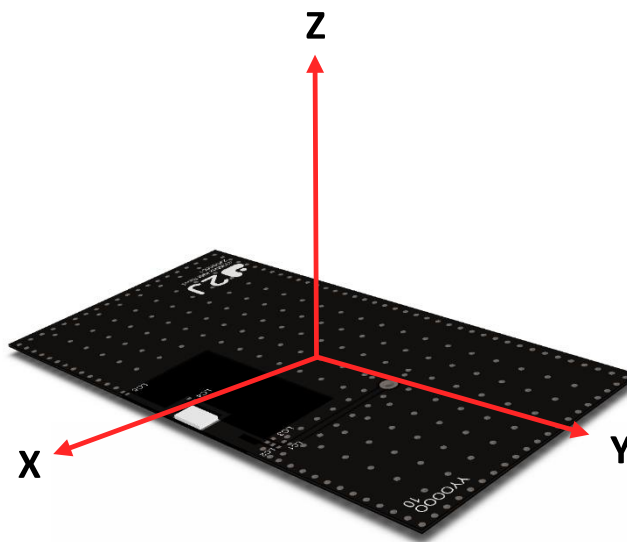
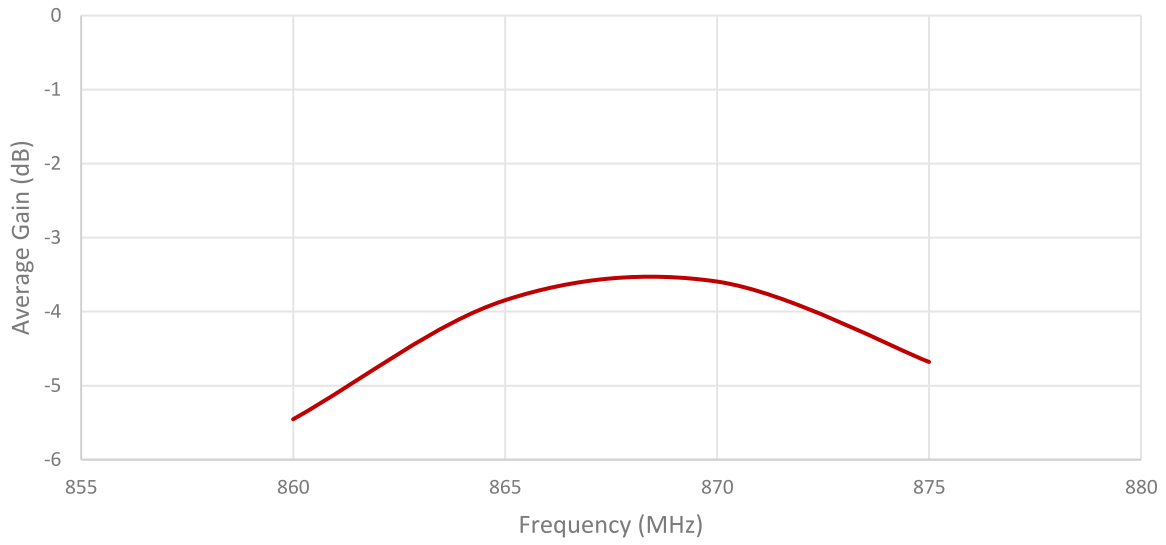

Radiation pattern reference

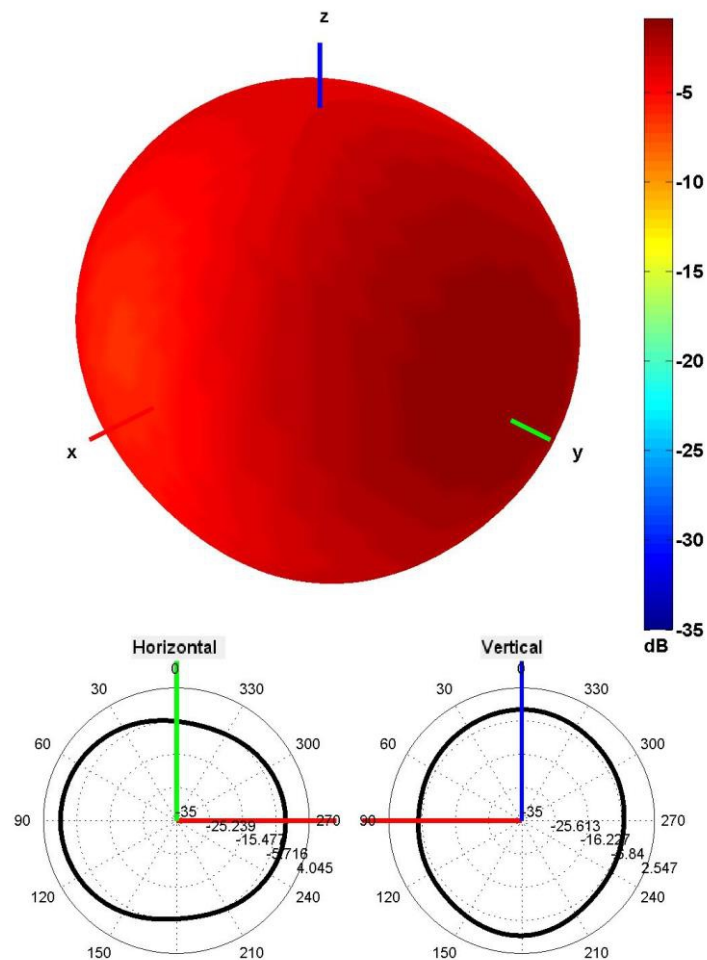

868 MHz Radiation pattern

## 4. PCB Layout

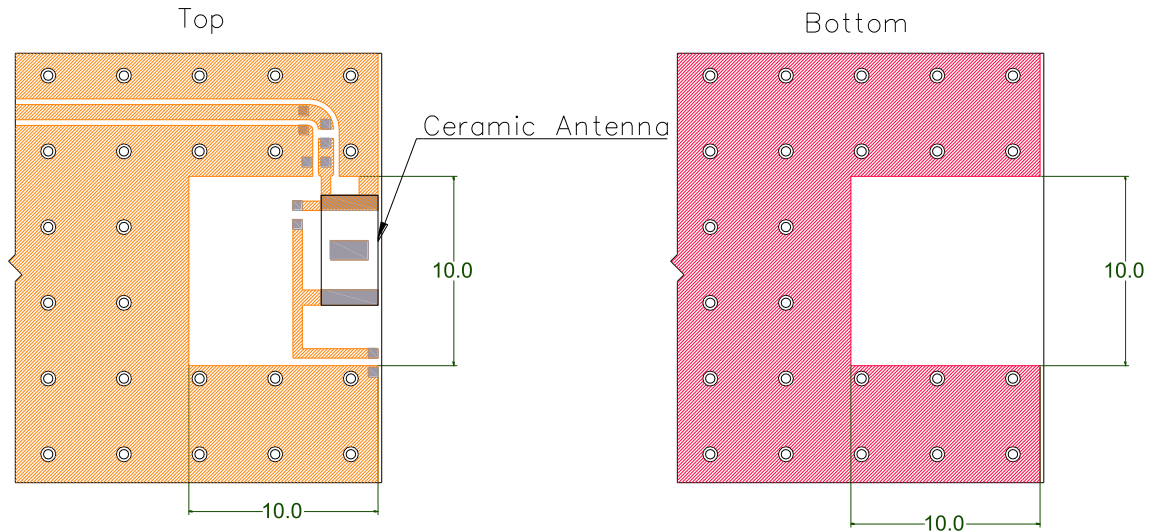

■ Solder Region

■ Top Copper Region

■ Bottom Copper Region

□ Copper-Free Region

Minimum area required for antenna integration (10mm × 10mm)

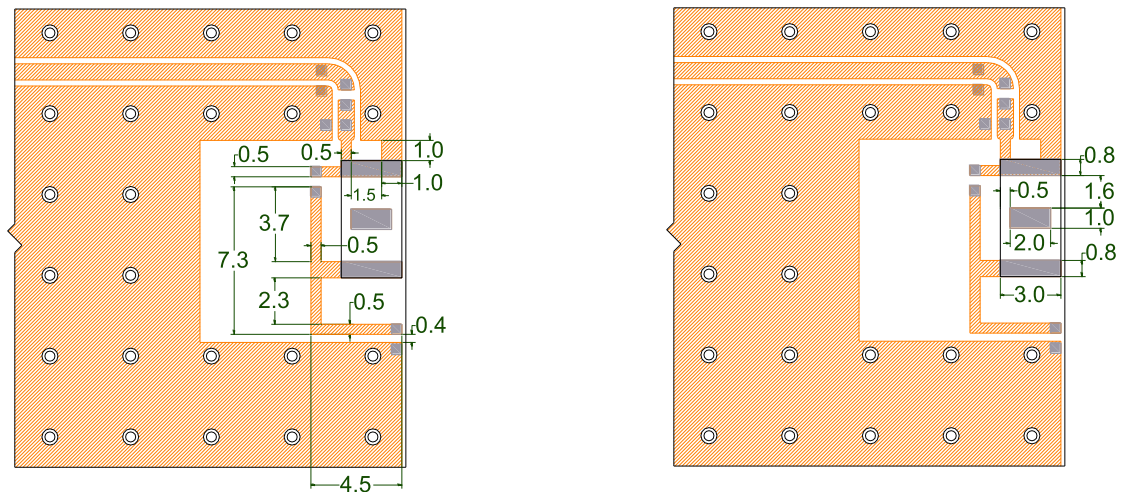

■ Solder Region

■ Top Copper Region

□ Copper-Free Region

Layout dimensions for antenna integration (mm)

## 5. Matching Components

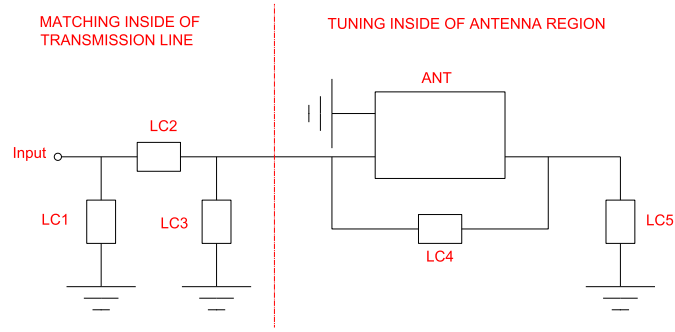

Matching Network Schematic

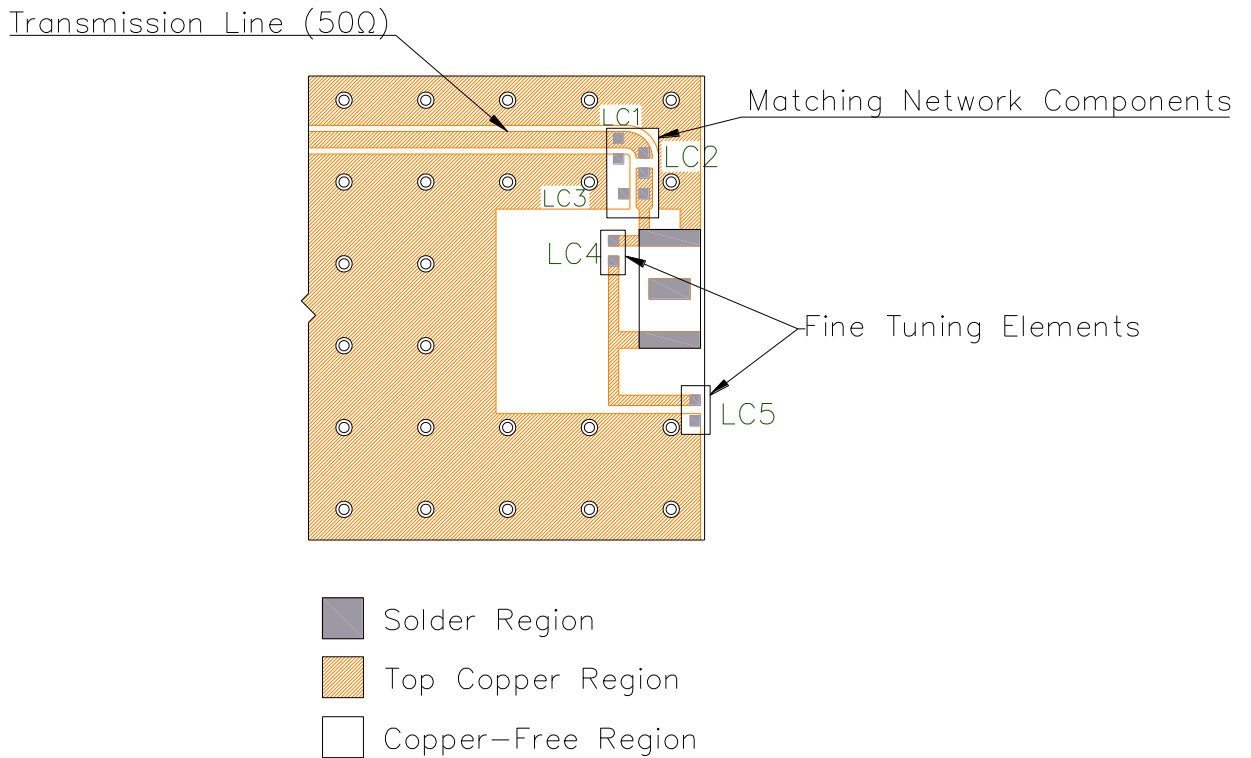

Matching network drawing (LC1=OPEN, LC2=0 Ohm, LC3=OPEN, LC4=2.7pF±0.05pF, LC5=3.6pF±0.05pF)



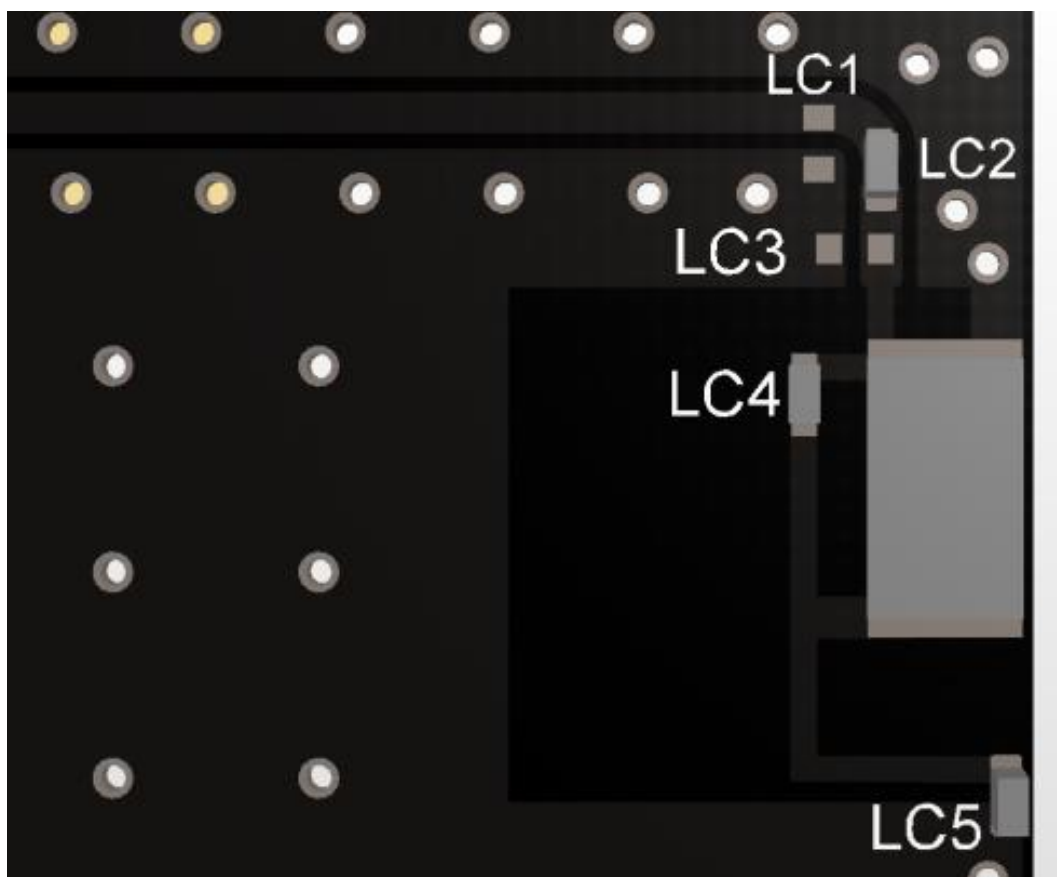

Matching network drawing (LC1=OPEN, LC2=0 Ohm, LC3=OPEN, LC4=2.7pF±0.05pF,LC5=3.6pF±0.05pF)

**REFLOW TEMPERATURE PROFILE**

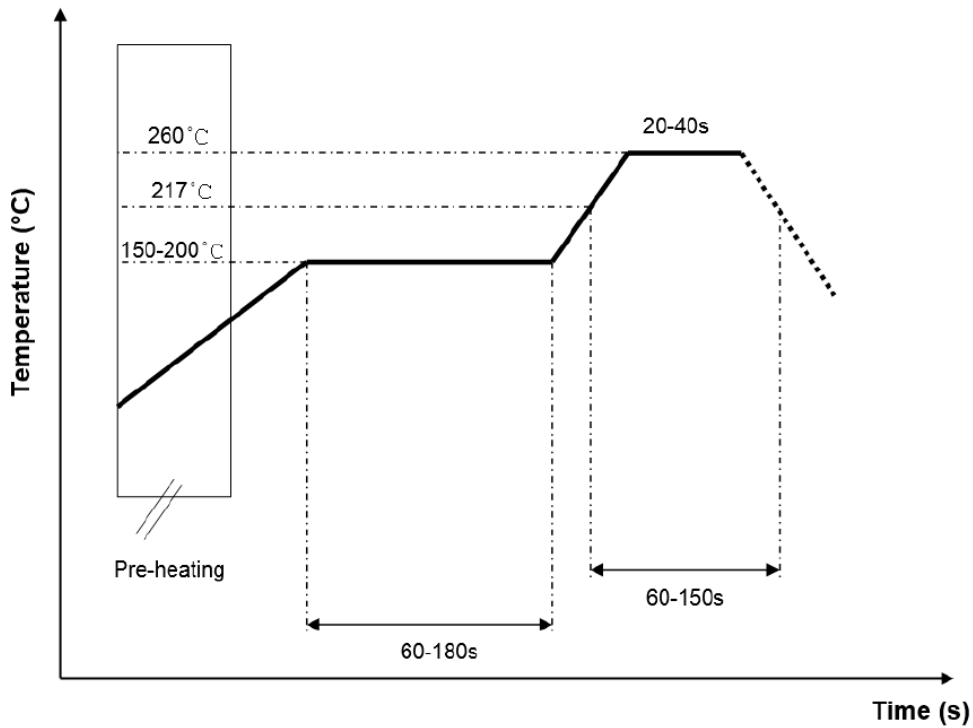

**6. Evaluation Board**

80mm x 40mm

80mm x 40mm

80mm x 40mm

80mm x 10.8mm  
(PCB: 0.8mm, Antenna: 0.5mm,  
Connector: 9.5mm)

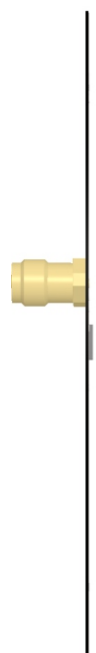
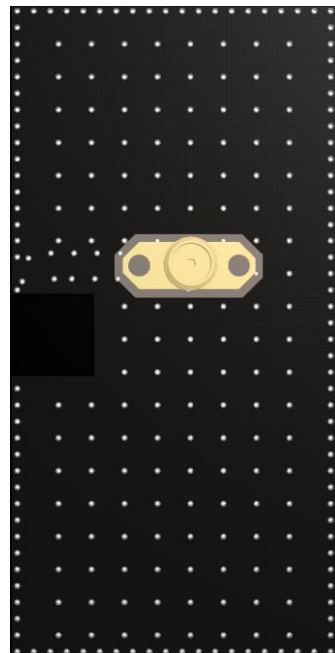
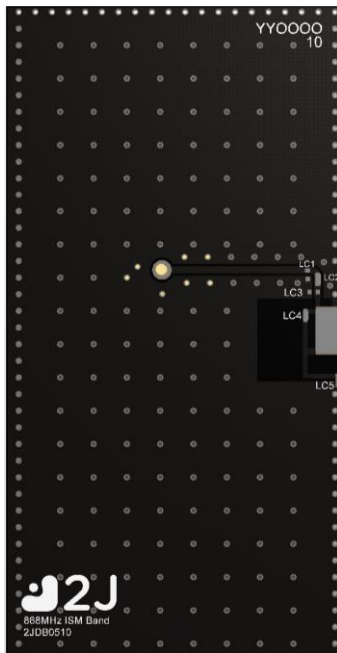
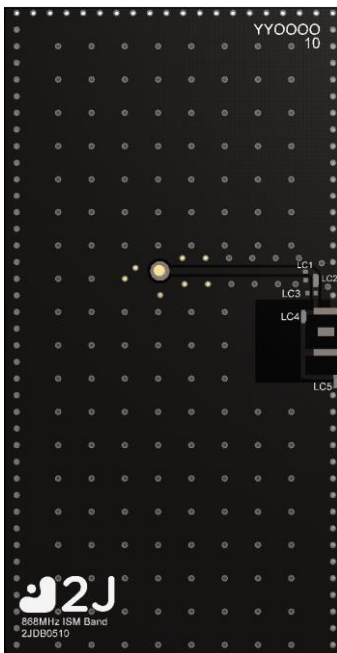

Front View without Antenna

Front View with Antenna

Back View

Side View

## 7. Antenna drawings

Bottom

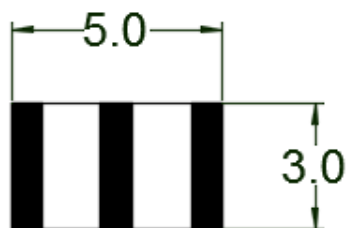

Top



Feed Point

Front



Right

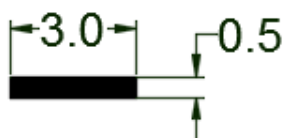

Dimensions for ceramic antenna 5 x 3 x 0.5 mm

## 8. Tape and Reel Information

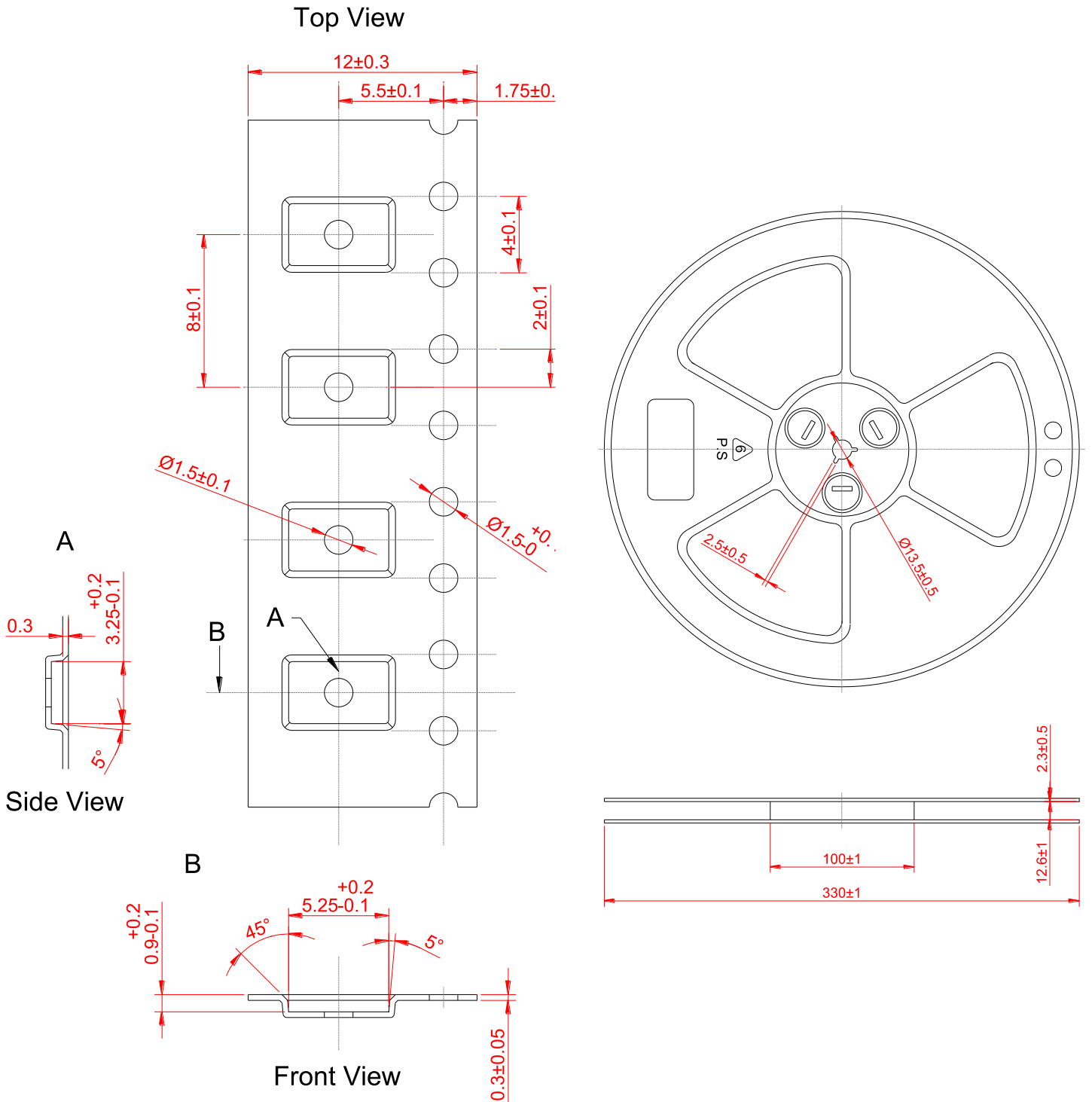

Tape and Reel Specifications

## 9. Packaging

### PACKAGING SPECIFICATION

<b>Antenna</b>	2JL10
<b>REEL</b>	
<b>Max Quantity per Reel</b>	6000
<b>REEL BOX</b>	
<b>Reels per Box</b>	2
<b>Max Quantity per Box</b>	12000
<b>Reel Box Dimensions (cm)</b>	18 x 18 x 3.6
<b>Reel Box Weight (Kg)</b>	0.7
<b>CARTON</b>	
<b>Reels per Carton</b>	2
<b>Max Quantity per Carton</b>	120,000
<b>Reel Carton Dimensions (cm)</b>	40.5 x 24.7 x 22.5
<b>Reel Carton Weight (Kg)</b>	7

### Storage Conditions:

- Storage Temperature Range: -40 °C to +85 °C
- Oxidizable material. Store for 12 months in vacuum sealed bag.
- Repack material after use by re-sealing package.

## 10. Antenna Images

