





SPECIFICATION

Product Model: PV05018Y0140U

DESIGNED	CHECKED	Approved
		

Approval by Customer:

Ok

NG, Problem survey

Approved By _____



Table of Contents

List	Description	Page No.
	Cover	1
	Revision Record	2
	Table of Contents	3
1	Scope	4
2	General Information	4
3	External Dimensions	5
4	Interface Description	6
5	Absolute Maximum Ratings	7
6	DC Characteristics	7
7	Timing Characteristics	8
8	Backlight Characteristics	14
9	Optical Characteristics	14
10	Reliability Test Conditions and Methods	17
11	Inspection Standard	18
12	Handling Precautions	22
13	Precaution for Use	23
14	Packing Method	23



1. Scope

This specification defines general provisions as well as inspection standards for TFT module supplied by Kingtech Group Co.,Ltd.

If the event of unforeseen problem or unspecified items may occur, naturally shall negotiate and agree to solution.

2. General Information

LCM

ITEM	STANDARD VALUES	UNITS
LCD type	5.0" TFT	--
Dot arrangement	800 (RGB) × 480	dots
Color filter array	RGB vertical stripe	--
Display mode	Normally BLACK IPS	-
Viewing Direction	ALL Viewing	
Driver IC	ST7265	--
Module size	120.9(W) × 76.05(H) × 2.95(T)	mm
Active area	108(W) × 64.8(H)	mm
Dot pitch	0.135(W) × 0.135(H)	mm
Interface	LVDS Interface	--
Operating temperature	-30 ~ +85	°C
Storage temperature	-30 ~ +85	°C
Back Light	18White LED	--
Weight	TBD	g



3. External Dimensions

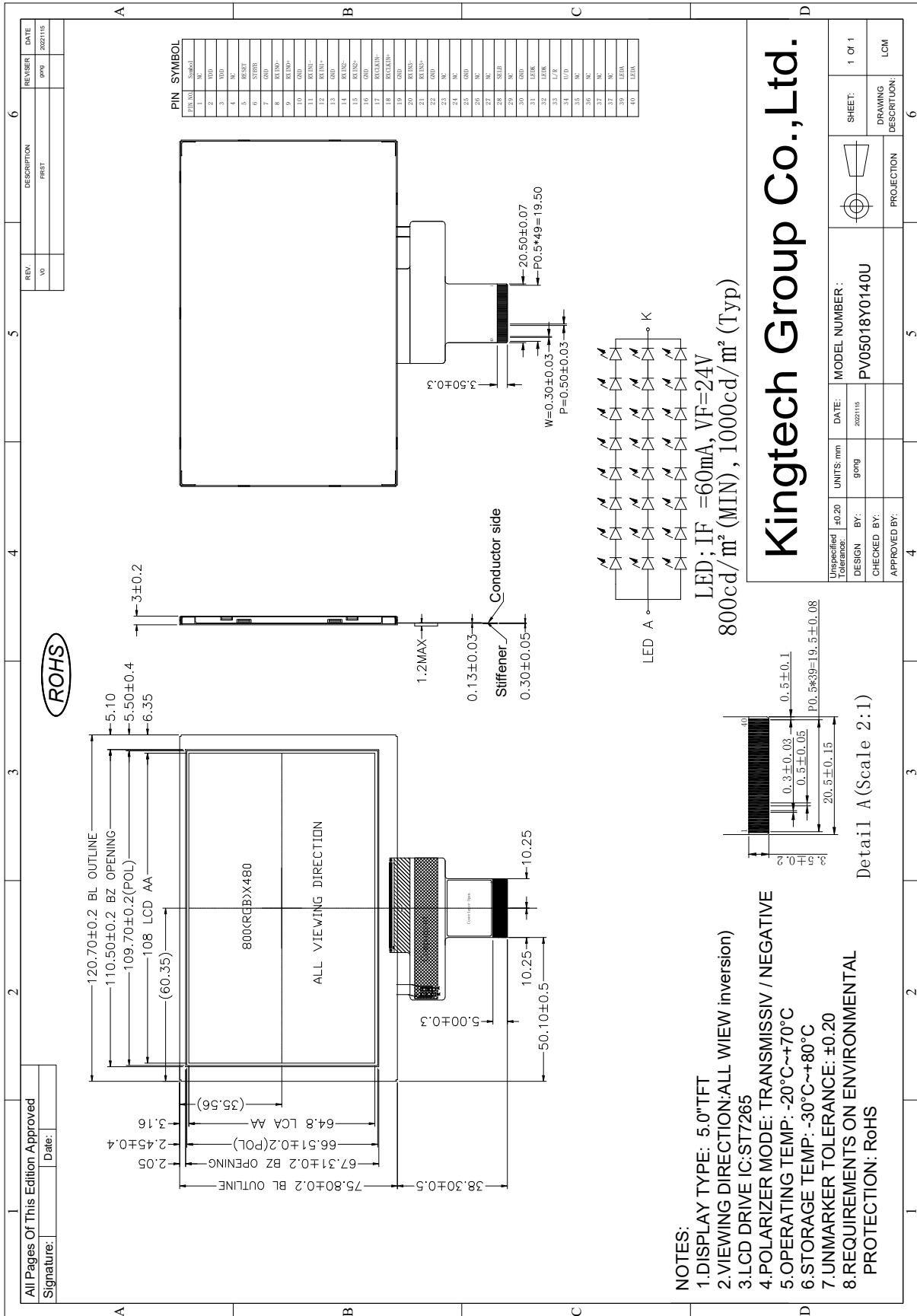



4. Interface Description

No.	Symbol	I/O	Function
1	NC	-	Not connect
2,3	VDD	P	Digital power
4	NC	-	Not connect
5	RESET	I	Global reset pin. Active low to enter reset state. Suggest to connecting with an RC reset circuit for stability. Normally pull high. (R=100K _Ω , C=1μF)
6	STBYB	I	Standby mode, normally pull high STBYB="1", normal operation STBYB="0", Standby mode
7	GND	P	Ground
8	RXIN0-	I	Negative LVDS differential data inputs
9	RXIN0+	I	Positive LVDS differential data inputs
10	GND	P	Ground
11	RXIN1-	I	Negative LVDS differential data inputs
12	RXIN1+	I	Positive LVDS differential data inputs
13	GND	P	Ground
14	RXIN2-	I	Negative LVDS differential data inputs
15	RXIN2+	I	Positive LVDS differential data inputs
16	GND	P	Ground
17	RXCLK-	I	Negative LVDS differential clock inputs
18	RXCLK+	I	Positive LVDS differential clock inputs
19	GND	P	Ground
20	RXIN3-	I	Negative LVDS differential data inputs
21	RXIN3+	I	Positive LVDS differential data inputs
22	GND	P	Ground
23,24	NC	-	Not connect
25	GND	P	Ground
26,27	NC	-	Not connect
28	SELB	I	Set LVDS 3 Lane/4 Lane, SELB=H(default),LVDS 4 Lane, SELB=L,LVDS 3 Lane.
29	NC	-	Not connect
30	GND	P	Ground
31,32	LED K	P	LED backlight (Cathode).
33	L/R	I	Horizontal inversion, L/R=H(default),from left to right, L/R=L,from right to left.
34	U/D	I	Vertical inversion, U/D=H(default),from up to down, U/D=L,from down to up .
35~38	NC	I/O	Not connect
39,40	LED A	P	LED backlight (Anode).

I: input , O: output , P: Power



5. Absolute Maximum Ratings

Item	Symbol	Min.	Max.	Unit
Logic Supply Voltage	VDD	-0.5	5.0	V
Input Voltage	V _{in}	-0.3	VDD +0.3	V
Operating Temperature	T _{OP}	-30	85	°C
Storage Temperature	T _{ST}	-30	85	°C
Storage Humidity	HD	-	90	%RH

6. DC Characteristics

Item	Symbol	Min.	Typ.	Max.	Unit	Remark
Logic Supply Voltage	VDD	3.0	3.3	3.6	V	-
Input High Voltage	V _{IH}	0.7VDD	-	VDD	V	-
Input Low Voltage	V _{IL}	GND	-	0.3 VDD	V	-
Output High Voltage	V _{OH}	VDD-0.4	-	VDD	V	-
Output Low Voltage	V _{OL}	GND	-	GND+0.4	V	-
Standby Current	I _{sc}	-	-	50	uA	-
Operation Current	I _{oc}	-	80	-	mA	-



7. Timing Characteristics

7.1. Power ON Sequence

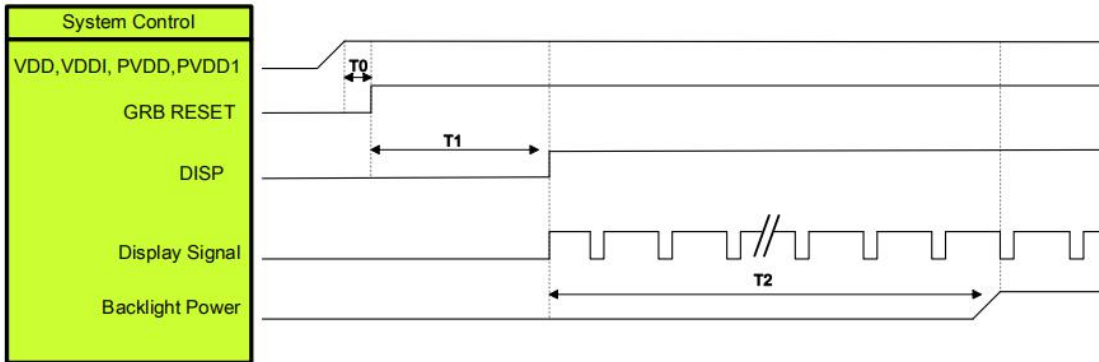

Symbol	Description	Min. Time	Unit
T0	System power stability to GRB RESET signal	0	ms
T1	GRB RESET= "High" to DISP="High"	10	ms
T2	Display Signal output to Backlight Power on	250	ms

Note: RGB interface Display signal: DCLK; VSYNC; HSYNC; DE; DR[7:0]; DG[7:0]; DB[7:0]

7.2. Power OFF Sequence

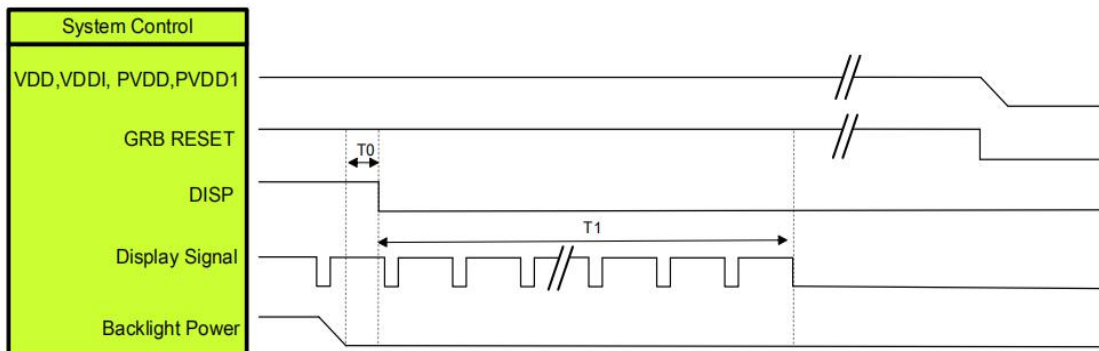

Symbol	Description	Min. Time	Unit
T0	Backlight Power off to DISP="Low"	5	ms
T1	DISP="Low" to IC internal voltage discharge complete	100	ms

Note: RGB interface Display signal: DCLK; VSYNC; HSYNC; DE; DR[7:0]; DG[7:0]; DB[7:0]



7.3 LVDS Interface

7.3.1 LVDS Input Pin Mapping Table

Pin Name RGB (LVDS)	LVDS 3 lane	LVDS 4 Lane
DCLKN	DCLKN	DCLKN
DCLKP	DCLKP	DCLKP
DB0	RX0P	RX0P
DB1	RX0N	RX0N
DB2	RX1P	RX1P
DB3	RX1N	RX1N
DB4	RX2P	RX2P
DB5	RX2N	RX2N
DB6	-	RX3P
DB7	-	RX3N

Note: Symbol "-" means reserve pin and should fix to "L" by DGND.

7.3.2 4 Lane JEIDA Data Format Color Bit Map

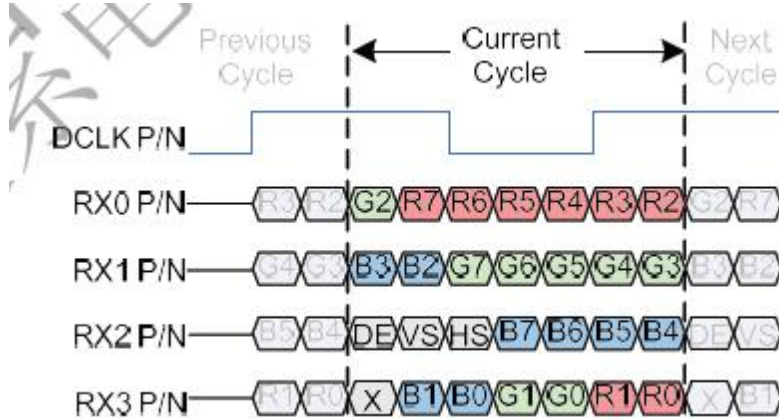

7.3.3 3 Lane JEIDA Data Format Color Bit Map

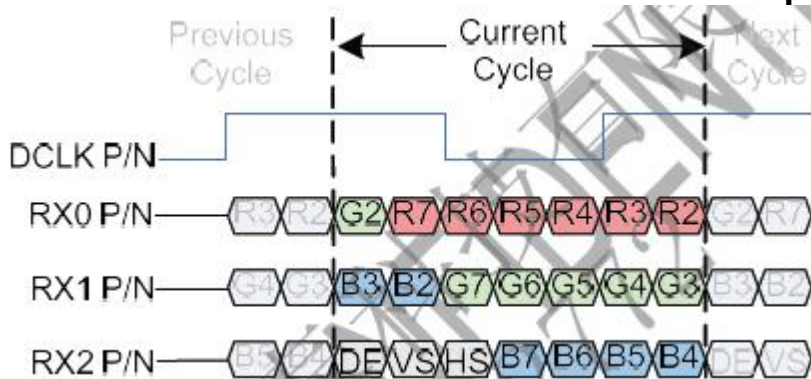



8. Backlight Characteristic

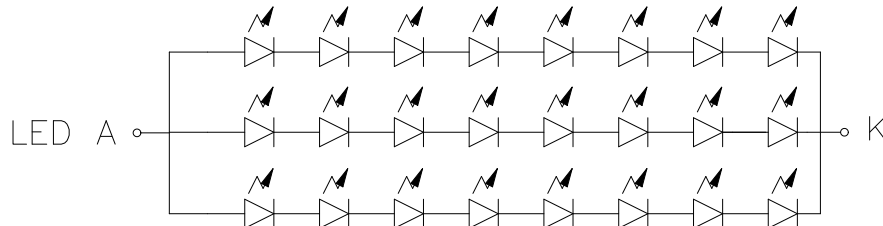

Item	Symbol	MIN	TYP	MAX	UNIT	Test Condition
Supply Voltage	Vf	22	24	25.2	V	If=60mA
Supply Current	If	-	60	-	mA	
Luminous Intensity for LCM	-	800	1000	-	cd/m ²	If=60mA
Uniformity for LCM	-	80	-	-	%	If=60mA
Life Time	-	30000		-	Hr	If=60mA
Backlight Color	White					

9. Optical Characteristics

Item	Conditions	Min.	Typ.	Max.	Unit	Note	
Viewing Angle (CR>10)	Horizontal	θ_L	-	80	-	degree	(1),(2),(6)
		θ_R	-	80	-		
	Vertical	θ_T	-	80	-		
		θ_B	-	80	-		
Contrast Ratio	Center	800	1000	-	-	(1),(3),(6)	
Response Time	Tr+Tf	-	30	40	ms	(1),(4),(6)	
CF Color Chromaticity (CIE1931)	Red x	Typ. -0.05	0.629	Typ. +0.05	-	(1), (6)	
	Red y		0.326		-		
	Green x		0.337		-		
	Green y		0.5466		-		
	Blue x		0.136		-		
	Blue y		0.143		-		
	White x		0.320		-		
White y	0.345	-					
NTSC		45	50	-	%	(1),(6)	

Note (1) The electro-optical response time measurements shall be made as FIGURE 5 shown in Appendix by switching the “data” input signal ON and OFF. The times needed for the luminance to change from 10% to 90% is Td, and 90% to 10% is Tr.

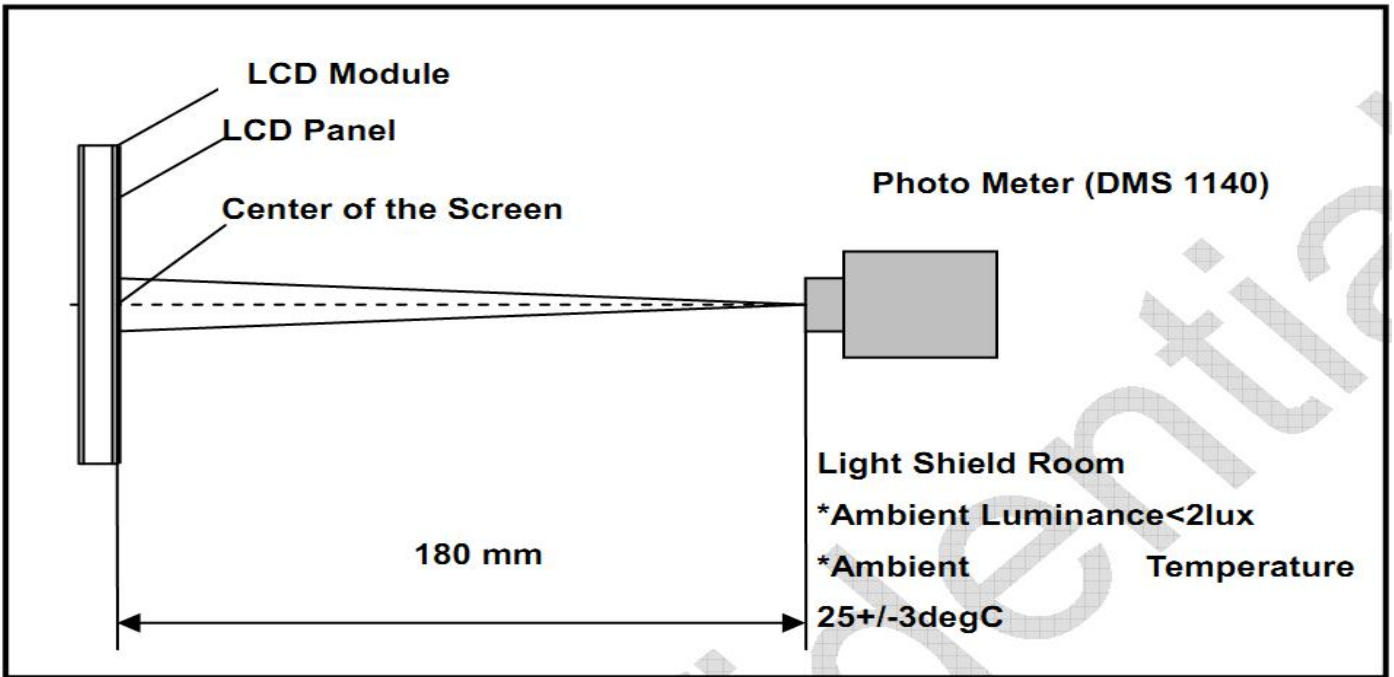

Note (2) Definition of Viewing Angle

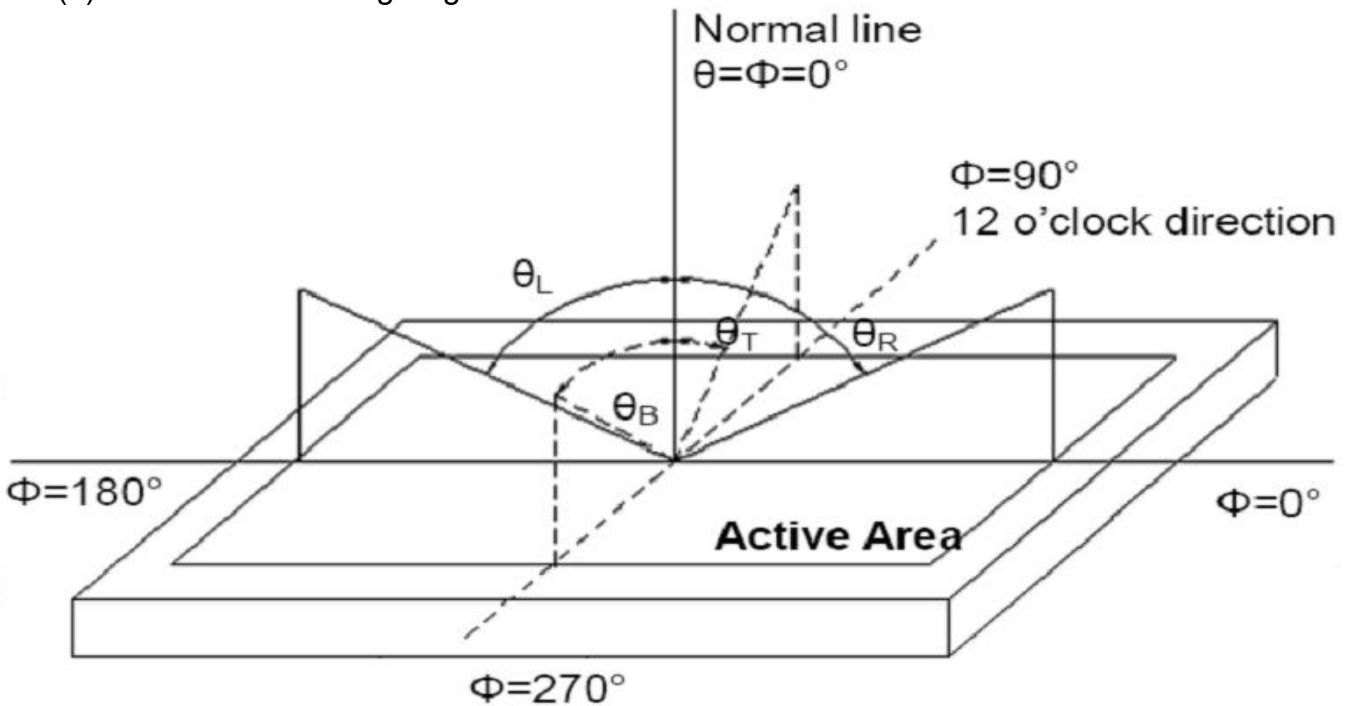

Note (3) Definition of Contrast Ratio (CR)

The contrast ratio can be calculated by the following expression

$$\text{Contrast Ratio (CR)} = L_{63} / L_0$$



L63: Luminance of gray level 63, L0: Luminance of gray level 0

Note (4) Definition of response time

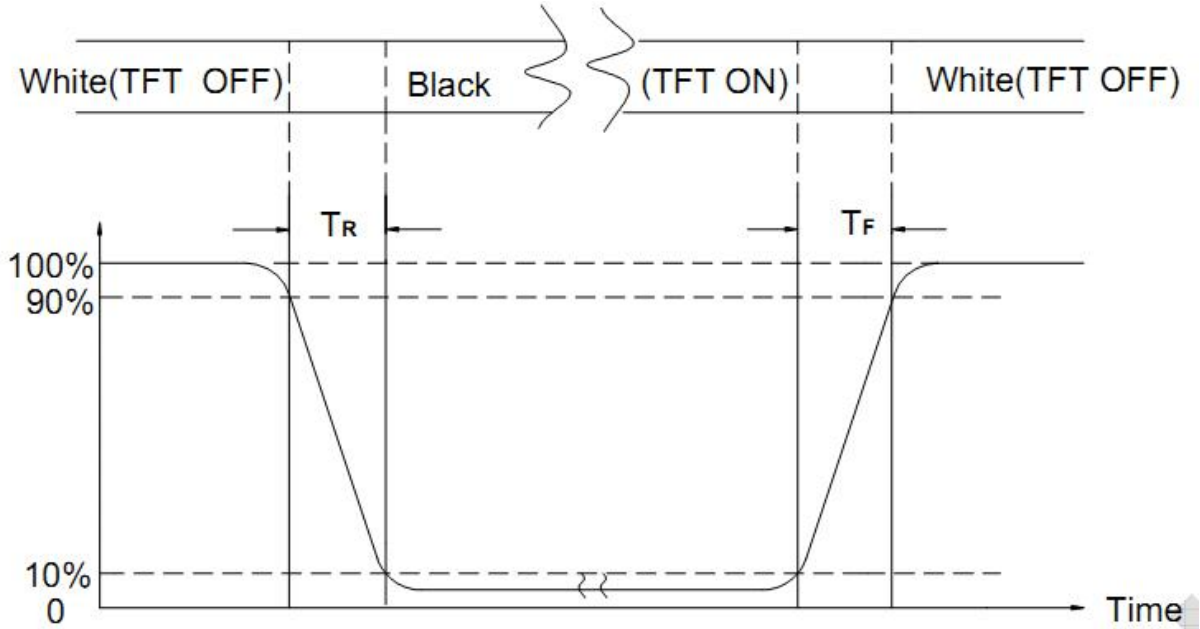

Note (5) Definition of Transmittance (Module is without signal input)

$$\text{Transmittance} = \text{Center Luminance of LCD} / \text{Center Luminance of Back Light} \times 100\%$$

Note (6) Definition of color chromaticity (CIE1931)

Color coordinates measured at the center point of LCD



10. Reliability Test Conditions and Methods

NO.	TEST ITEMS	TEST CONDITION	INSPECTION AFTER TEST
①	High Temperature Storage	85°C±5°C×96Hours	Inspection after 2~4hours storage at room temperature, the samples should be free from defects: 1, Air bubble in the LCD. 2, Seal leak. 3, Non-display. 4, Missing segments. 5, Glass crack. 6, Current IDD is twice higher than initial value. 7, The surface shall be free from damage. 8, The electric characteristic requirements shall be satisfied.
②	Low Temperature Storage	-30°C±5°C×96Hours	
③	High Temperature Operating	85°C±5°C×96Hours	
④	Low Temperature Operating	-30°C±5°C×96Hours	
⑤	Temperature Cycle(Storage)	-30°C ↔ 25°C ↔ 85°C (30min) ← (5min) → (30min) 1cycle Total 10cycle	
⑥	Damp Proof Test (Storage)	50°C±5°C×90%RH×96Hours	
⑦	Vibration Test	Frequency:10Hz~55Hz~10Hz Amplitude:1.5MM X,Y,Z direction for total 3hours (packing condition test will be tested by a carton)	
⑧	Drooping Test	Drop to the ground from 1M height one time every side of carton. (packing condition test will be tested by a carton)	
⑨	ESD Test	Voltage:±8KV,R:330Ω,C:150PF,Air Mode,10times	

REMARK:

- 1, The Test samples should be applied to only one test item.
- 2, Sample side for each test item is 5~10pcs.
- 3,For Damp Proof Test, Pure water(Resistance > 10MΩ)should be used.
- 4,In case of malfunction defect caused by ESD damage, if it would be recovered to normal state after resetting, it would be judge as a good part.
- 5, EL evaluation should be accepted from reliability test with humidity and temperature: Some defects such as black spot/blemish can happen by natural chemical reaction with humidity and Fluorescence EL has.
- 6, Failure Judgment Criterion: Basic Specification Electrical Characteristic, Mechanical Characteristic, Optical Characteristic.
- 7.①~ ⑥ test exclude Polaroid



11. Inspection Standard

11.1. QUALITY :

THE QUALITY OF GOODS SUPPLIED TO PURCHASER SHALL COME UP TO THE FOLLOWING STANDARD.

11.1.1. THE METHOD OF PRESERVING GOODS

AFTER DELIVERY OF GOODS FROM AMSON TO PURCHASER. PURCHASER SHALL CONTROL THE LCM AT -10°C TO 40°C ,AND IT MIGHT BE DESIRABLE TO KEEP AT THE NORMAL ROOM TEMPERATURE AND HUMIDITY UNTIL INCOMING INSPECTION OR THROWING INTO PROCESS LINE.

11.1.2. INCOMING INSPECTION

(A) THE METHOD OF INSPECTION

IF PURCHASER MAKE AN INCOMING INSPECTION , A SAMPLING PLAN SHALL BE APPLIED ON THE CONDITION THAT QUALITY OF ONE DELIVERY SHALL BE REGARDED AS ONE LOT.

(B) THE STANDARD OF QUALITY

ISO-2859-1 (SAME AS MIL-STD-105E) , LEVEL II SINGLE PLAN.

CLASS	AQL(%)
CRITICAL	0.4 %
MAJOR	0.65 %
MINOR	1.5 %
TOTAL	1.5 %

EVERY ITEM SHALL BE INSPECTED ACCORDING TO THE CLASS.

(C) MEASURE

IF AS THE RESULT OF ABOVE RECEIVING INSPECTION , A LOT OUT IS DISCOVERED. PURCHASER SHALL BE INFORM SELLER OF IT WITHIN SEVEN DAYS. BUT FIRST SHIPMENT WITHIN FOURTEEN DAYS.

11.1.3. WARRANTY POLICY

AMSON WILL PROVIDE ONE-YEAR WARRANTY FOR THE PRODUCTS ONLY IF UNDER SPECIFICATION OPERATING CONDITIONS. AMSON WILL REPLACE NEW PRODUCTS FOR THESE DEFECT PRODUCTS WHICH UNDER WARRANTY PERIOD AND BELONG TO THE RESPONSIBILITY OF AMSON.

11.2. CHECKING CONDITION

11.2.1. CHECKING DIRECTION SHALL BE IN THE 45 DEGREE AREA TO FACE THE SAMPLE.

11.2.2. CHECKER SHALL SEE OVER 300±25 mm. WITH BARE EYES FAR FROM SAMPLE AND USING 2 PCS. OF 20W FLUORESCENT LAMP.



11.3. INSPECTION PLAN :

CLASS	ITEM	JUDGEMENT	CLASS
PACKING & INDICATE	1. OUTSIDE AND INSIDE PACKAGE	"MODEL NO." , "LOT NO." AND "QUANTITY" SHOULD INDICATE ON THE PACKAGE.	Minor
	2. MODEL MIXED AND QUANTITY	OTHER MODEL MIXED.....REJECTED QUANTITY SHORT OR OVER.....REJECTED	Critical
	3. PRODUCT INDICATION	"MODEL NO." SHOULD INDICATE ON THE PRODUCT	Major
ASSEMBLY	4. DIMENSION, LCD GLASS SCRATCH AND SCRIBE DEFECT.	ACCORDING TO SPECIFICATION OR DRAWING.	Major
APPEARANCE	5. VIEWING AREA	POLARIZER EDGE OR LCD'S SEALING LINE IS VISABLE IN THE VIEWING AREAREJECTED	Minor
	6. BLEMISH · BLACK SPOT · WHITE SPOT IN THE LCD AND LCD GLASS CRACKS	ACCORDING TO STANDARD OF VISUAL INSPECTION(INSIDE VIEWING AREA)	Minor
	7. BLEMISH · BLACK SPOT WHITE SPOT AND SCRATCH ON THE POLARIZER	ACCORDING TO STANDARD OF VISUAL INSPECTION(INSIDE VIEWING AREA)	Minor
	8. BUBBLE IN POLARIZER	ACCORDING TO STANDARD OF VISUAL INSPECTION(INSIDE VIEWING AREA)	Minor
	9. LCD'S RAINBOW COLOR	STRONG DEVIATION COLOR (OR NEWTON RING) OF LCD.....REJECTED. OR ACCORDING TO LIMITED SAMPLE (IF NEEDED, AND INSIDE VIEWING AREA)	Minor
ELECTRICAL	10. ELECTRICAL AND OPTICAL CHARACTERISTICS (CONTRAST· VOP · CHROMATICITY ... ETC)	ACCORDING TO SPECIFICATION OR DRAWING . (INSIDE VIEWING AREA)	Critical
	11.MISSING LINE	MISSING DOT · LINE · CHARACTERREJECTED	Critical
	12.SHORT CIRCUIT· WRONG PATTERN DISPLAY	NO DISPLAY · WRONG PATTERN DISPLAY · CURRENT CONSUMPTION OUT OF SPECIFICATION..... REJECTED	Critical
	13. DOT DEFECT (FOR COLOR AND TFT)	ACCORDING TO STANDARD OF VISUAL INSPECTION	Minor

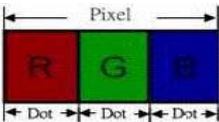

NO.	CLASS	ITEM	JUDGEMENT										
11.4.1	MINOR	BLACK AND WHITE SPOT FOREIGN MATERIEL DUST IN THE CELL BLEMISH SCRATCH	(A) ROUND TYPE: unit: mm <table border="1" style="width: 100%;"> <thead> <tr> <th>DIAMETER (mm.)</th> <th>ACCEPTABLE Q' TY</th> </tr> </thead> <tbody> <tr> <td>$\varnothing \leq 0.2$</td> <td>Distances $\geq 1\text{mm}$</td> </tr> <tr> <td>$0.2 < \varnothing \leq 0.3$</td> <td>3 (Distance $\geq 5\text{mm}$)</td> </tr> <tr> <td>$0.3 < \varnothing \leq 0.4$</td> <td>2 (Distance $\geq 5\text{mm}$)</td> </tr> <tr> <td>$0.4 < \varnothing$</td> <td>0</td> </tr> </tbody> </table> <p>NOTE: $\varnothing = (\text{LENGTH} * \text{WIDTH}) / 2$</p>	DIAMETER (mm.)	ACCEPTABLE Q' TY	$\varnothing \leq 0.2$	Distances $\geq 1\text{mm}$	$0.2 < \varnothing \leq 0.3$	3 (Distance $\geq 5\text{mm}$)	$0.3 < \varnothing \leq 0.4$	2 (Distance $\geq 5\text{mm}$)	$0.4 < \varnothing$	0
			DIAMETER (mm.)	ACCEPTABLE Q' TY									
$\varnothing \leq 0.2$	Distances $\geq 1\text{mm}$												
$0.2 < \varnothing \leq 0.3$	3 (Distance $\geq 5\text{mm}$)												
$0.3 < \varnothing \leq 0.4$	2 (Distance $\geq 5\text{mm}$)												
$0.4 < \varnothing$	0												
(S) LINE TYPE: unit: mm <table border="1" style="width: 100%;"> <thead> <tr> <th>LENGTH</th> <th>WIDTH</th> <th>ACCEPTABLE QTY</th> </tr> </thead> <tbody> <tr> <td>.....</td> <td>$W \leq 0.03$</td> <td>Distance $\geq 1\text{mm}$</td> </tr> <tr> <td>$L \leq 4.0$</td> <td>$0.03 < W \leq 0.05$</td> <td>3 (Distanced $\geq 15\text{mm}$)</td> </tr> <tr> <td>.....</td> <td>$0.05 < W$</td> <td>FOLLOW ROUND TYPE</td> </tr> </tbody> </table> <p>NOTE: $\varnothing = (\text{LENGTH} * \text{WIDTH}) / 2$</p>	LENGTH	WIDTH	ACCEPTABLE QTY	$W \leq 0.03$	Distance $\geq 1\text{mm}$	$L \leq 4.0$	$0.03 < W \leq 0.05$	3 (Distanced $\geq 15\text{mm}$)	$0.05 < W$	FOLLOW ROUND TYPE	
LENGTH	WIDTH	ACCEPTABLE QTY											
.....	$W \leq 0.03$	Distance $\geq 1\text{mm}$											
$L \leq 4.0$	$0.03 < W \leq 0.05$	3 (Distanced $\geq 15\text{mm}$)											
.....	$0.05 < W$	FOLLOW ROUND TYPE											
11.4.2	MINOR	BUBBLE IN POLARIZER DENT ON POLARIZER	unit: mm. <table border="1" style="width: 100%;"> <thead> <tr> <th>DIAMETER</th> <th>ACCEPTABLE Q' TY</th> </tr> </thead> <tbody> <tr> <td>$\varnothing < 0.2$</td> <td>Distance $\geq 1\text{mm}$</td> </tr> <tr> <td>$0.2 < \varnothing \leq 0.3$</td> <td>4 (Distance $\geq 15\text{mm}$)</td> </tr> <tr> <td>$0.3 < \varnothing \leq 0.4$</td> <td>3 (Distance $\geq 15\text{mm}$)</td> </tr> <tr> <td>$0.4 < \varnothing$</td> <td>0</td> </tr> </tbody> </table>	DIAMETER	ACCEPTABLE Q' TY	$\varnothing < 0.2$	Distance $\geq 1\text{mm}$	$0.2 < \varnothing \leq 0.3$	4 (Distance $\geq 15\text{mm}$)	$0.3 < \varnothing \leq 0.4$	3 (Distance $\geq 15\text{mm}$)	$0.4 < \varnothing$	0
DIAMETER	ACCEPTABLE Q' TY												
$\varnothing < 0.2$	Distance $\geq 1\text{mm}$												
$0.2 < \varnothing \leq 0.3$	4 (Distance $\geq 15\text{mm}$)												
$0.3 < \varnothing \leq 0.4$	3 (Distance $\geq 15\text{mm}$)												
$0.4 < \varnothing$	0												
11.4.3	MINOR	Dot Defect	<table border="1" style="width: 100%;"> <thead> <tr> <th>Items</th> <th>ACC. Q' TY</th> </tr> </thead> <tbody> <tr> <td>Bright dot</td> <td>$N \leq 1$ (Distance $\geq 15\text{mm}$)</td> </tr> <tr> <td>Dark dot</td> <td>$N \leq 3$ (Distance $\geq 15\text{mm}$)</td> </tr> </tbody> </table> <p>Pixel Define :</p>  <p>Note</p> <ol style="list-style-type: none"> The definition of dot: The size of a defective dot over 1 of whole dot is regarded as one defective dot. Definition: $< 1/2$ dot and visible by 5% ND filter Bright dot: Dots appear bright and unchanged in size in which LCD panel is displaying under black pattern. Dark dot: Dots appear dark and unchanged in size in which LCD panel is displaying under pure red, green, blue pattern. 	Items	ACC. Q' TY	Bright dot	$N \leq 1$ (Distance $\geq 15\text{mm}$)	Dark dot	$N \leq 3$ (Distance $\geq 15\text{mm}$)				
Items	ACC. Q' TY												
Bright dot	$N \leq 1$ (Distance $\geq 15\text{mm}$)												
Dark dot	$N \leq 3$ (Distance $\geq 15\text{mm}$)												
11.4.4	MINOR	Mura	Not visible through 5% ND filter in 50% gray or judge by limit sample if necessary										

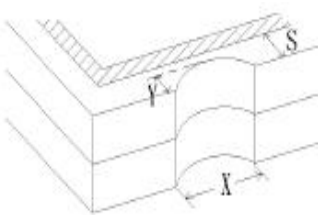
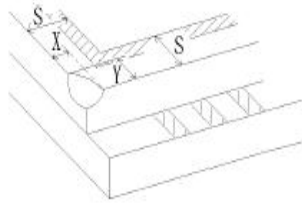
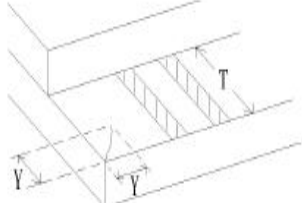
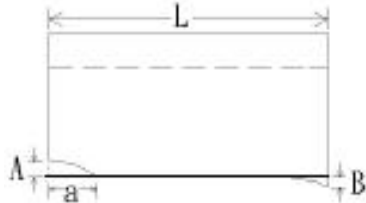
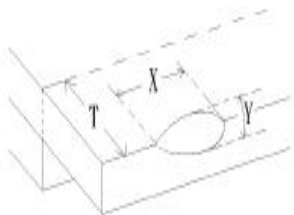
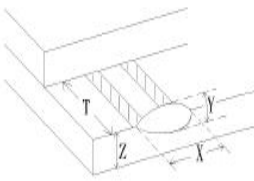
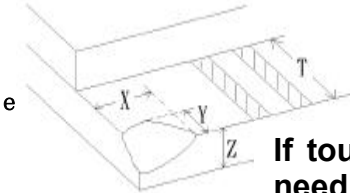

NO.	CLASS	ITEM	JUDGEMENT
11.4.5	MINOR	LCD GLASS CHIPPING	 <p>X ≥ 3mm Y > S</p> <p>Reject</p>
11.4.6	MINOR	LCD GLASS CHIPPING	 <p>X OR Y > S</p> <p>Reject</p>
11.4.7	MINOR	LCD GLASS CRACK	 <p>Continuous burst NG</p> <p>Reject</p>
11.4.8	MINOR	LCD GLASS SCRIBE DEFECT	 <p>According to dimension</p>
11.4.9	MINOR	LCD GLASS CHIPPING (on the terminal area)	 <p>Y < 1/2Z Y ≥ 0.5mm X ≥ 3mm</p> <p>Reject</p>
11.4.10	MINOR	LCD GLASS CHIPPING (on the terminal surface)	 <p>Y < 1/2Z Y ≥ 0.5mm X ≥ 3mm</p> <p>Reject</p>
11.4.11	MINOR	LCD GLASS CHIPPING	 <p>X ≥ 3mm Y > T</p> <p>If touch the electrode lines the need to retain the two-thirds electrode lines</p> <p>R</p>



12. Handling Precautions

12.1 Mounting method

The LCD panel of KINGTECH TFT module consists of two thin glass plates with polarizers which easily be damaged. And since the module is so constructed as to be fixed by utilizing fitting holes in the printed circuit board.

Extreme care should be needed when handling the LCD modules.

12.2 Caution of LCD handling and cleaning

When cleaning the display surface, Use soft cloth with solvent

[Recommended below] and wipe lightly

- Isopropyl alcohol
- Ethyl alcohol

Do not wipe the display surface with dry or hard materials that will damage the polarizer surface.

Do not use the following solvent:

- Water
- Aromatics

Do not wipe ITO pad area with the dry or hard materials that will damage the ITO patterns

Do not use the following solvent on the pad or prevent it from being contaminated:

- Soldering flux
- Chlorine (Cl) , Sulfur (S)

If goods were sent without being silicon coated on the pad, ITO patterns could be damaged due to the corrosion as time goes on.

If ITO corrosion happens by miss-handling or using some materials such as Chlorine (Cl), Sulfur (S) from customer, Responsibility is on customer.

12.3 Caution against static charge

The LCD module uses C-MOS LSI drivers, so we recommend that you:

Connect any unused input terminal to power or ground, do not input any signals before power is turned on, and ground your body, work/assembly areas, and assembly equipment to protect against static electricity.

12.4 packing

- Module employs LCD elements and must be treated as such.
- Avoid intense shock and falls from a height.
- To prevent modules from degradation, do not operate or store them exposed direct to sunshine or high temperature/humidity

12.5 Caution for operation

- It is an indispensable condition to drive LCD's within the specified voltage limit since the higher voltage than the limit causes the shorter LCD life.
- An electrochemical reaction due to direct current causes LCD's undesirable deterioration, so that the use of direct current drive should be avoided.
- Response time will be extremely delayed at lower temperature than the operating temperature range and on the other hand at higher temperature LCD's show dark color in them. However those phenomena do not mean malfunction or out of order with LCD's, which will come back in the specified operation temperature.
- If the display area is pushed hard during operation, some font will be abnormally displayed but it resumes normal condition after turning off once.
- Slight dew depositing on terminals is a cause for electro-chemical reaction resulting in terminal open circuit.



Usage under the maximum operating temperature, 50%Rh or less is required.

12.6 storing

In the case of storing for a long period of time for instance, for years for the purpose or replacement use, the following ways are recommended.

- Storage in a polyethylene bag with the opening sealed so as not to enter fresh air outside in it. And with no desiccant.
- Placing in a dark place where neither exposure to direct sunlight nor light's keeping the storage temperature range.
- Storing with no touch on polarizer surface by the anything else.

[It is recommended to store them as they have been contained in the inner container at the time of delivery from us

12.7 Safety

- It is recommendable to crash damaged or unnecessary LCD's into pieces and wash off liquid crystal by either of solvents such as acetone and ethanol, which should be burned up later.
- When any liquid leaked out of a damaged glass cell comes in contact with your hands, please wash it off well with soap and water

13. Precaution for Use

13.1

A limit sample should be provided by the both parties on an occasion when the both parties agreed its necessity. Judgment by a limit sample shall take effect after the limit sample has been established and confirmed by the both parties.

13.2

On the following occasions, the handing of problem should be decided through discussion and agreement between responsible of the both parties.

- When a question is arisen in this specification
- When a new problem is arisen which is not specified in this specifications
- When an inspection specifications change or operating condition change in customer is reported to KINGTECH TFT , and some problem is arisen in this specification due to the change
- When a new problem is arisen at the customer s operating set for sample evaluation in the customer site.

14. Packing Method

TBD