



**SPECIFICATION
FOR
LCD Module
PV04005TD25E**

MODULE:	
CUSTOMER:	



REVISION STATUS

Version	Revise Date	Page	Content	Modified by
V1.0	20220216	-	First Issued.	YANG



TABLE OF CONTENTS

1.General Description

2. Mechanical Characteristics

3. Pin Description

4. Electrical Characteristics

5. Optical Characteristics

6. Quality Specifications

7. Reliability

8. Handling Precaution

9. Packagingfigure



1. General Description

* DESCRIPTION

PV04005TD25E is a color active matrix TFT (Thin Film Transistor) LCD (liquid crystal display) that uses amorphous silicon TFT as a switching device. This model is composed of a Transmissive type TFT-LCD Panel, driver circuit, back-light unit. The resolution of a 3.97" TFT-LCD contains 480 x 800 pixels, and can display up to 16.7M colors.

* Features

- Low Input Voltage: VCC: 2.5~3.3V;IOVCC: 1.65~3.3V
- Display Colors of TFT LCD: 16.7M colors
- Interface: MIPI-2 Lanes
- Internal Power Supply Circuit.

General Information Items	Specification	Unit	Note
	Main Panel		
Display area(AA)	51.84(H) *86.4 (V)	mm	-
Driver element	a-Si TFT active matrix	-	-
Display colors	16.7M	colors	-
Number of pixels	480(RGB) *800	dots	-
Pixel arrangement	RGB vertical stripe	-	-
Pixel pitch	0.108 (H) *0.108(V)	mm	-
Viewing angle	All	o'clock	-
Drive IC	ST7701S	-	-
Display mode	Normally black	-	-
Operating temperature	-20~+60	°C	-
Storage temperature	-30~+70	°C	-

Mechanical Information

Item		Min.	Typ.	Max.	Unit	Note
Module size	Horizontal(H)	-	57.14	-	mm	±0.15
	Vertical(V)	-	96.85	-	mm	±0.15
	Depth(D)	-	2.11	-	mm	±0.1
Weight		-	TBD	-	g	-



3.Pin Description

3.1 LCM

Pin NO.	Symbol	Level	Function
1	LEDA	H	Backlight+
2	LEDK	L	Backlight-
3	GND	L	Ground
4	NC		NC
5	NC		NC
6	GND	L	Ground
7	TDPO	H/L	HSSI_D0+ are differential data signal line.
8	TDN 0	H/L	HSSI_D0- are differential data signal line.
9	GND	L	Ground
10	TCP	H/L	HSSI_CLK+ are differential data signal line.
11	TCN	H/L	HSSI_CLK- are differential data signal line.
12	GND	L	Ground
13	TDP 1	H/L	HSSI_D1+ are differential data signal line.
14	TDN 1	H/L	HSSI_D1- are differential data signal line.
15	GND	L	Ground
16	NC		NC
17	NC		NC
18	GND	L	Ground
19	RST	H/L	Hardware reset pin
20	TE	H/L	Tearing effect output
21	ID	H	P Connctet 10K resistance to GND)
22	VDD	H	Power supply(2.5-3.3V)
23	GND	L	Ground
24	IOVCC	H	Power supply(1.65-3.3V)
25	GND	L	Ground



4. ELECTRICAL CHARACTERISTICS

4.1 ABSOLUTE MAXIMUM RATINGS

Item	Symbol	Values		Unit	Remark
		Min	Max.		
Supply Voltage for Logic circuit	VDDIO	1.65	3.3	V	
Supply Voltage for analog circuit	Vcc	2.5	3.3	V	

4.2 DC ELECTRICAL CHARACTERISTICS

4.2.1 OPERATING CONDITIONS

Typical Operating Conditions (Ta=25°C)

Item	Symbol	Values			Unit	Remark
		Min	Typ	Max.		
Power Supply	Vcc	2.5	2.8	3.3	V	
Power Supply	VDDIO	1.65	1.8	3.3	V	
Normal mode Current consumption	Icc	-	80	-	mA	VCC=2.8V
TFT Gate ON Voltage	VGH	10	-	20	V	
TFT Gate OFF Voltage	VGL	-15	-	-7.5	V	

4.2.2 BACKLIGHT UNIT (GND=0V)

Item	Symbol	Values			Unit	Remark
		Min	Typ	Max.		
Forward supply Voltage	Vf	11.6		13.6	V	
Forward supply Current	If	-	40	-	mA	
LCM Luminance	Lv	350	400	-	cd/m2	I _B =40mA
Uniformity	/	80			%	-



4.3 MIPI Interface Characteristics

4.3.1

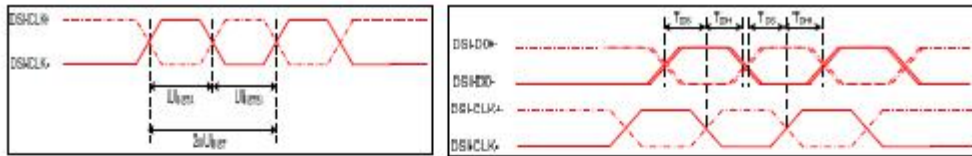

Figure 4 DSI clock channel timing

Figure 5 Rising and falling time on clock and data channel

VDD1=1, VDD=2 & AGND=DGND=0V, Ta=25 °C

Signal	Symbol	Parameter	MIN	MAX	Unit	Description
DSI-CLK+/-	2xUI _{INSTA}	Double UI instantaneous	4	25	ns	
DSI-CLK+/-	UI _{INSTA} UI _{INSTB}	UI instantaneous halves	2	12.5	ns	UI = UI _{INSTA} = UI _{INSTB}
DSI-Dn+/-	tDS	Data to clock setup time	0.15	-	UI	
DSI-Dn+/-	tDH	Data to clock hold time	0.15	-	UI	

Table 7 Mipi Interface- High Speed Mode Timing Characteristics

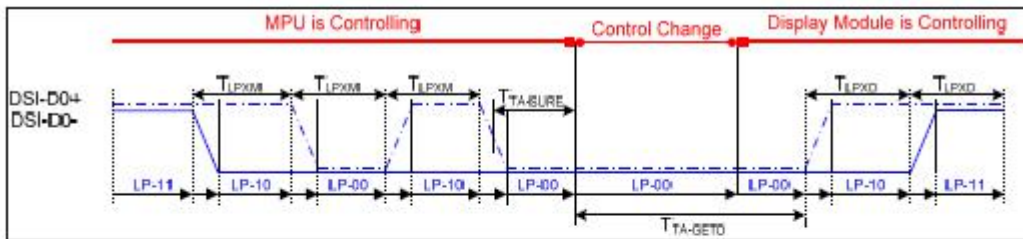

Figure 6 Bus Turnaround (BTA) from display module to MPU Timing

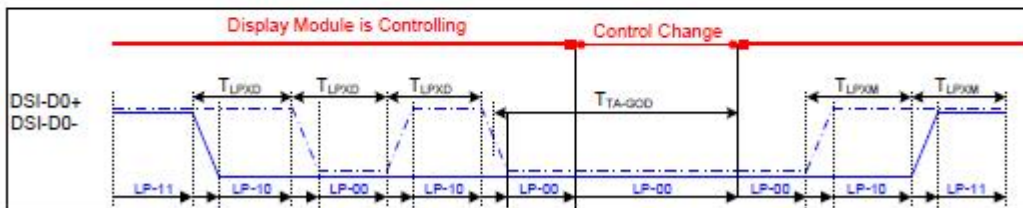

Figure 7 Bus Turnaround (BTA) from MPU to display module Timing

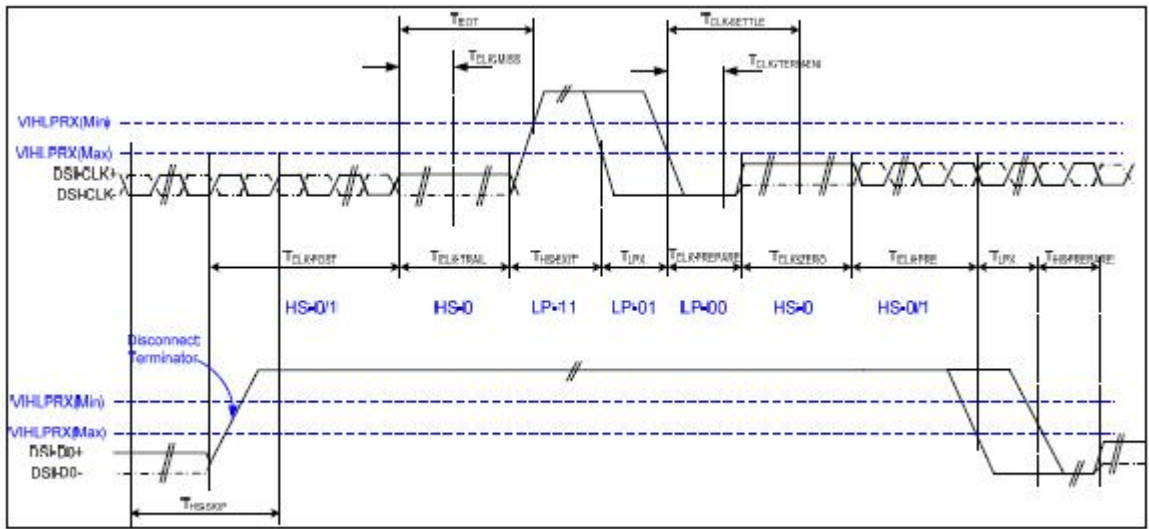

Figure 8 Clock lanes- High Speed Mode to/from Low Power Mode Timing

BTA from Display module Timing to HOST



Signal	Symbol	Parameter	MIN	MAX	Unit	Description
Low Power Mode to High Speed Mode Timing						
DSI-Dn+/-	TLPX	Length of any low power state period	50	-	ns	Input
DSI-Dn+/-	THS-PREPARE	Time to drive LP-00 to prepare for HS transmission	40+4 UI	85+6 UI	ns	Input
DSI-Dn+/-	THS-TERM-EN	Time to enable data receiver line termination measured from when Dn crosses VILMAX	-	35+4 UI	ns	Input
DSI-Dn+/-	THS-PREPARE + THS-ZERO	THS-PREPARE + time to drive HS-0 before the sync sequence	140+ 10UI	-	ns	Input
High Speed Mode to Low Power Mode Timing						
DSI-Dn+/-	THS-SKIP	Time-out at display module to ignore transition period of EoT	40	55+4 UI	ns	Input
DSI-Dn+/-	THS-EXIT	Time to drive LP-11 after HS burst	100	-	ns	Input
DSI-Dn+/-	THS-TRAIL	Time to drive flipped differential state after last payload data bit of a HS transmission burst	60+4 UI	-	ns	Input
High Speed Mode to/from Low Power Mode Timing						
DSI-CLK+/-	TCLK-POS	Time that the MPU shall continue sending HS clock after the last associated data lane has transition to LP mode	60+5 2UI	-	ns	Input
DSI-CLK+/-	TCLK-TRAIL	Time to drive HS differential state after last payload clock bit of a HS transmission burst	60	-	ns	Input
DSI-CLK+/-	THS-EXIT	Time to drive LP-11 after HS burst	100	-	ns	Input
DSI-CLK+/-	TCLK-PREPARE	Time to drive LP-00 to prepare for HS transmission	38	95	ns	Input
DSI-CLK+/-	TCLK-TERM-EN	Time-out at clock lan display module to enable HS transmission	--	38	ns	Input
DSI-CLK+/-	TCLK-PREPARE + TCLK-ZERO	Minimum lead HS-0 drive period before starting clock	300	-	ns	Input
DSI-CLK+/-	TCLK-PRE	Time that the HS clock shall be driven prior to any associated data lane beginning the transition from LP to HS mode	8UI	-	ns	Input
DSI-CLK+/-	TEOT	Time form start of TCLK-TRAIL period to start of LP-11 state	-	105n s+12 UI	ns	Input



7.5.5 Reset Timing:

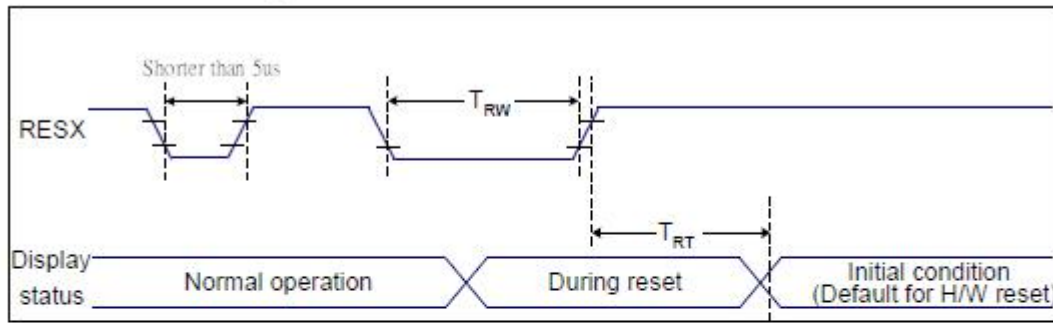

Figure 9 Reset Timing

VDD1=1.8, VDD=2.8, AGND=DGND=0V, Ta=25 ℃

Related Pins	Symbol	Parameter	MIN	MAX	Unit
RESX	TRW	Reset pulse duration	10	-	us
	TRT	Reset cancel	-	5 (Note 1, 5)	ms
			120 (Note 1, 6, 7)	ms	

Table 9 Reset Timing

Notes:

1. The reset cancel includes also required time for loading ID bytes, VCOM setting and other settings from NVM (or similar device) to registers. This loading is done every time when there is HW reset cancel time (TRT) within 5 ms after a rising edge of RESX.
2. Spike due to an electrostatic discharge on RESX line does not cause irregular system reset according to the table below:

RESX Pulse	Action
Shorter than 5us	Reset Rejected
Longer than 9us	Reset
Between 5us and 9us	Reset starts

3. During the Resetting period, the display will be blanked (The display is entering blanking sequence, which maximum time is 120 ms, when Reset Starts in Sleep Out -mode. The display remains the blank state in Sleep In -mode.) and then return to Default condition for Hardware Reset.

4. Spike Rejection also applies during a valid reset pulse as shown below:

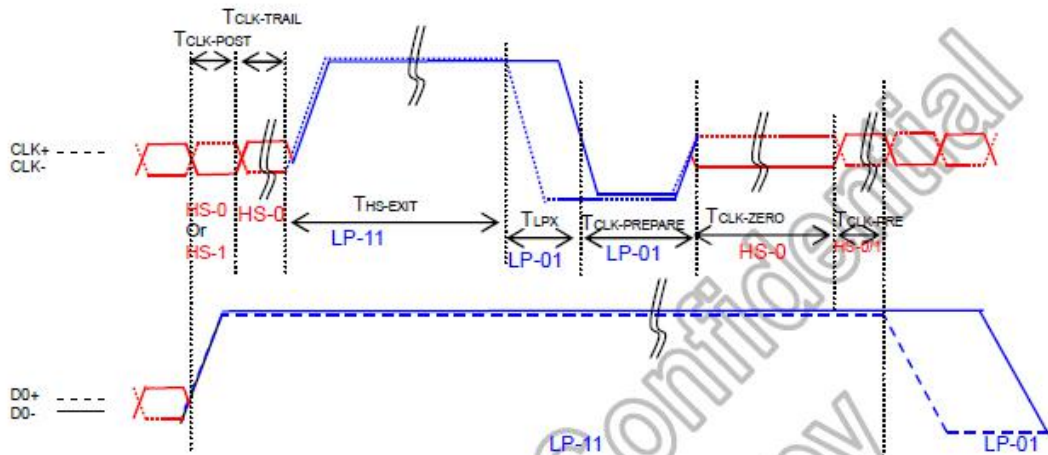

Signal	Item	Symbol	Spec.			Unit
			Min.	Typ.	Max.	
DSI_CP/ DSI_CN	Time that the MCU shall continue sending HS clock after the last associated Data Lane has transitioned to LP mode	TCLK-POST	60+52xUI	-	-	ns
	Time to drive HS differential state after last payload clock bit of a HS transmission burst	TCLK-TRAIL	60	-	-	ns
	Time to drive LP-11 after HS burst	THS-EXIT	100	-	-	ns
	Time to drive LP-00 to prepare for HS transmission	TCLK-PREPARE	38	-	95	ns
	Time-out at Clock Lane Display Module to enable HS Termination	TCLK-TERM-EN	-	-	38	ns
	Minimum lead HS-0 drive period before starting Clock	TCLK-PREPARE + TCLK-ZERO	300	-	-	ns
	Time that the HS clock shall be driven prior to any associated data Lane beginning the transition from LP to HS mode	TCLK-PRE	8xUI			

Clock Lanes High Speed Mode to/from Low Power Mode Timings

4.3.2. Reset input timing

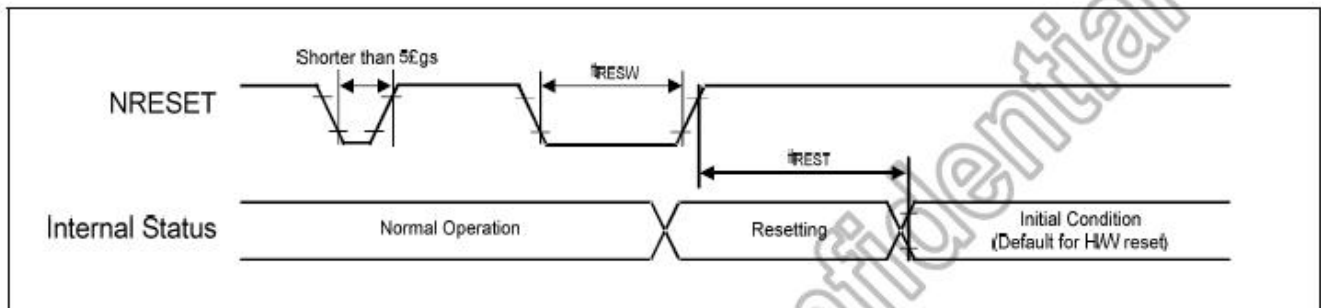

Reset input timing



Symbol	Parameter	Related Pins	Spec.			Note	Unit
			Min.	Typ.	Max.		
tRESW	Reset low pulse width ⁽¹⁾	NRESET	10	-	-	-	μs
tREST	Reset complete time ⁽²⁾	-	5	-	-	When reset applied during SLPIN mode	ms
		-	120	-	-	When reset applied during SLPOUT mode	ms

Reset input timing

Note: (1) Spike due to an electrostatic discharge on NRESET line does not cause irregular system reset according to the following table.

NRESET Pulse	Action
Shorter than 5 μs	Reset Rejected
Longer than 10 μs	Reset
Between 5 μs and 10 μs	Reset Start

- (2) During the resetting period, the display will be blanked (The display is entering blanking sequence, which Maximum time is 120 ms, when Reset Starts in Sleep Out –mode. The display remains the blank state in Sleep In –mode) and then return to Default condition for H/W reset.
- (3) During Reset Complete Time, ID and VCOM value in OTP will be latched to internal register during this period. This loading is done every time when there is HW reset complete time (tREST) within 5ms after a rising edge of NRESET.
- (4) Spike Rejection also applies during a valid reset pulse as shown as below:

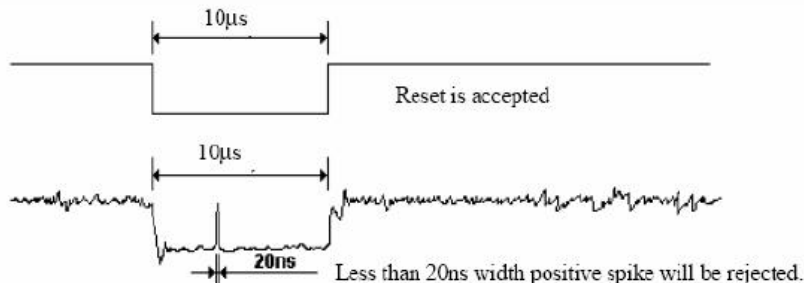

- (5) It is necessary to wait 5msec after releasing NRESET before sending commands. Also Sleep Out command cannot be sent for 120msec.



5. OPTICAL CHARACTERISTICS

(LCD optical specification)

Item		Symbol	Condition	Min.	Typ.	Max.	Unit	Note	
Transmittance (with Polarizer)		T (%)	θ=0 Normal viewing angle	—	4.14	—	%	Measuring with Polarizer · Reference Only	
Transmittance (without Polarizer)		T (%)		—	13.13	—	%		
Contrast		CR		720	900	—	—	(1)(2)	
Response time	Rising	T _R		—	16	21	msec	(1)(3)	
	Falling	T _F		—	19	24			
Color gamut		(%)		—	70	—	%	C-light	
Color chromaticity (CIE1931)	White	W _x		-0.02	0.310	+0.02	—	(1)(4) CF glass	
		W _y							
	Red	R _x							0.647
		R _y							0.317
	Green	G _x	0.275						
		G _y	0.582						
	Blue	B _x	0.140						
		B _y	0.088						
Viewing angle	Hor.	θ _L	—	80	—	—	(1)(4) Measuring with Polarizer · Reference Only		
		θ _R	—	80	—				
	Ver.	θ _U	—	80	—				
		θ _D	—	80	—				
Optima View Direction		Free					(5)		

Measuring Condition

- Measuring surrounding : dark room
- Ambient temperature : 25±2°C
- 15min. warm-up time.



Measuring Equipment

- FPM520 of Westar Display technologies, INC., which utilized SR-3 for Chromaticity and BM-5A for other optical characteristics.

Note (1) Definition of Viewing Angle:

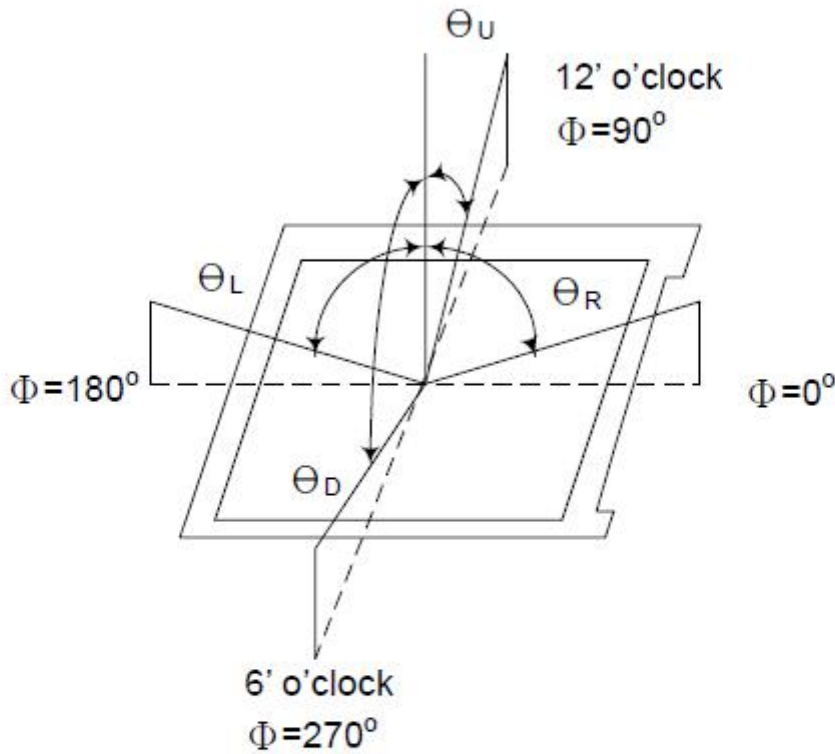

Note (2) Definition of Contrast Ratio (CR) :
measured at the center point of panel

$$CR = \frac{\text{Luminance with all pixels white}}{\text{Luminance with all pixels black}}$$



Note (3) Definition of Response Time : Sum of T_R and T_F

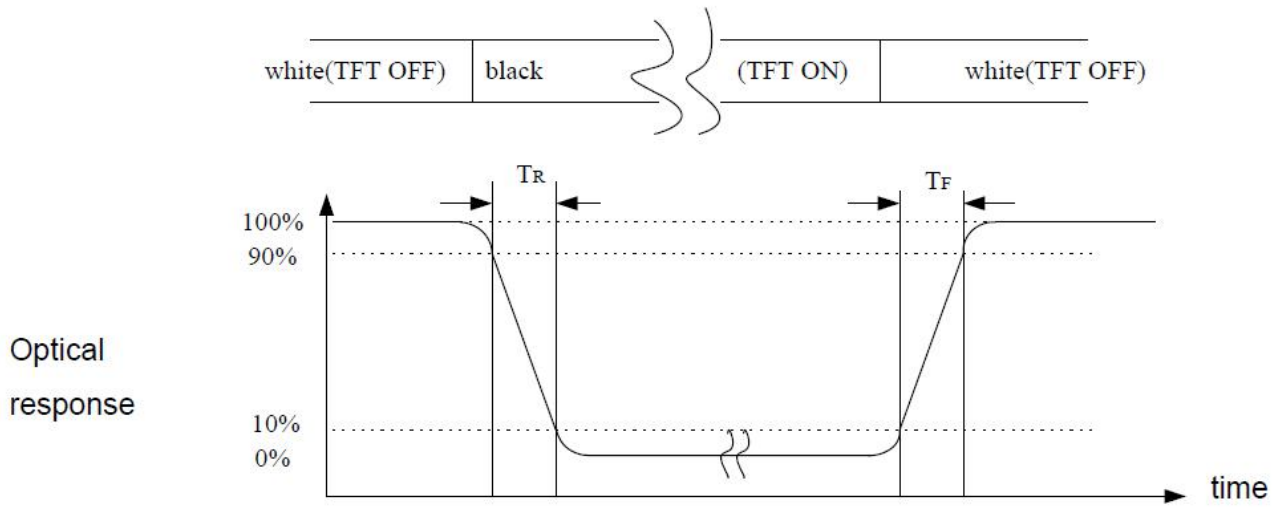

Note (4) Definition of optical measurement setup

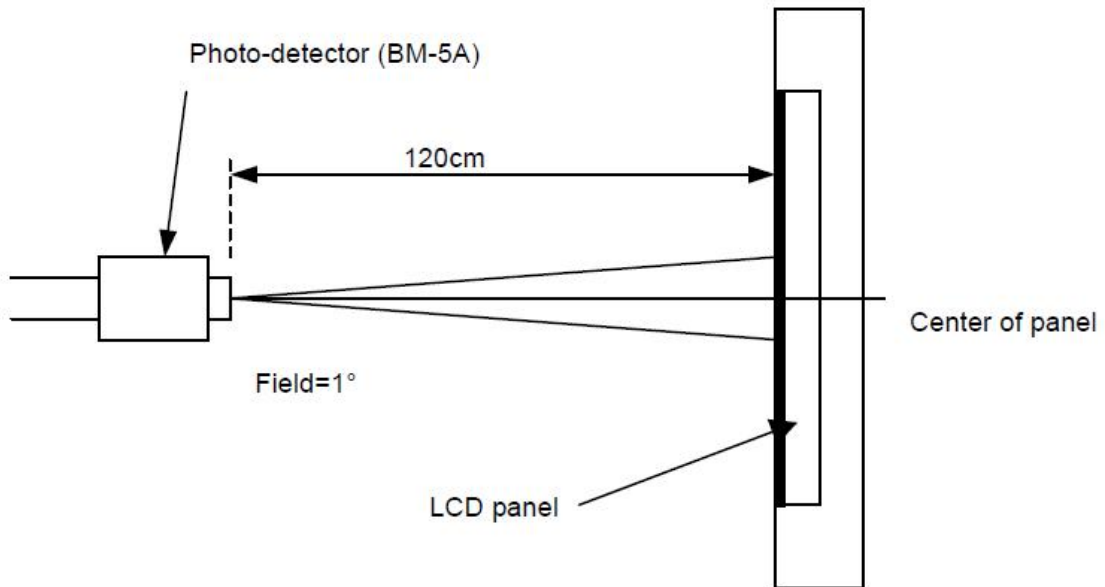



Note (5) Rubbing Direction (The different Rubbing Direction will cause the different optima view direction.)

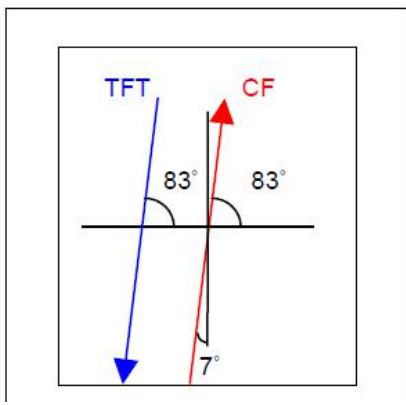



6. QUALITY SPECIFICATIONS

6.1 INSPECTION CONDITION

- (1) Inspect under 300~500Lux fluorescent light, leaving 30~35cm between panels and eyes, and between panels and lights.
- (2) Inspection condition is $23\pm 5^{\circ}\text{C}$, $50\pm 20\%RH$ maximum.

6.2 DEFINITION OF AREA

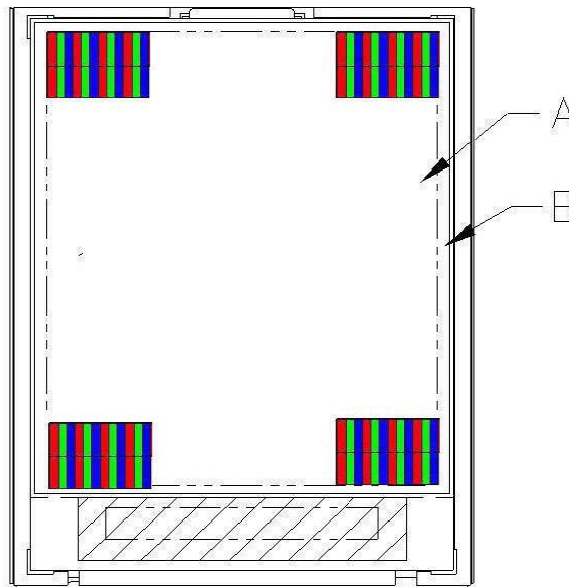



A Area : Viewing area.

B Area : Out of viewing.(outside viewing area)



6.3 INSPECTION SPECIFICATION

NO	Item	Acceptable specification	Judgment Criterion
1	Electrical Testing	<p>1-1 sub pixel classification</p> <ul style="list-style-type: none"> Sub Pixel: Number of sub pixel doesn't exceed one dot. <div style="text-align: center;">  <p>Sub Pixel (Dot)</p> </div> <p>a > Dark dot ----one Allowed b > Bright dot ---- one Allowed</p> <ul style="list-style-type: none"> Pixel : Three dots link together doesn't exceed ones <div style="text-align: center;">  <p>Pixel</p> </div> <p>1-2 Leakage to light</p> <ul style="list-style-type: none"> Leakage to light be not allowed. <p>1-3 Picture to shake</p> <ul style="list-style-type: none"> Picture had shake, twinkle and noise etc. instable of defect that be not allowed. <p>1-4 Function</p> <ul style="list-style-type: none"> No display or No function. Source Line, Gate Line. Contrast Ratio Current consumption exceeds product specifications. Display malfunction. 	<p>N ≦ 2</p> <p>N ≦ 0</p> <p>N=0</p> <p>N=0</p> <p>N=0</p>
2	Mechanical Dimension	<p>2-1 Mechanical Dimension exceeds product specifications.</p> <p>2-2 Out of frame and boss of plastic changed shape that be not allowed.</p>	N=0

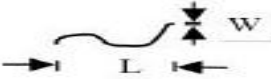
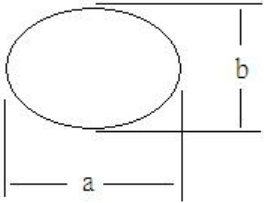

NO	Item	Acceptable specification	Judgment Criterion																																												
3	Cosmetic Inspection	<p>3-1 Blemish: Line shapes of defect</p> <table border="1" data-bbox="363 353 1315 707"> <thead> <tr> <th>Length</th> <th>Width</th> <th>Acceptable number</th> <th>Mini. space</th> </tr> </thead> <tbody> <tr> <td>---</td> <td>$W \leq 0.05$</td> <td>Ignore</td> <td rowspan="3">5 m m</td> </tr> <tr> <td>$L \leq 3.0$</td> <td>$0.05 < W \leq 0.08$</td> <td>4</td> </tr> <tr> <td>$L \leq 3.0$</td> <td>$0.08 < W \leq 0.15$</td> <td>3</td> </tr> <tr> <td>--</td> <td>$W > 0.15$</td> <td>Not allowed</td> <td>---</td> </tr> </tbody> </table> <p>L: length(mm) W: width(mm)</p>  <p>3-2 Blemish: dot shapes of defect.</p> <table border="1" data-bbox="434 965 1283 1200"> <thead> <tr> <th>Dimension</th> <th>Acceptable number</th> <th>Mini. Space</th> </tr> </thead> <tbody> <tr> <td>$\Phi \leq 0.15$</td> <td>Ignore</td> <td>---</td> </tr> <tr> <td>$0.15 < \Phi \leq 0.20$</td> <td>3</td> <td rowspan="2">5 m m</td> </tr> <tr> <td>$0.20 < \Phi \leq 0.30$</td> <td>2</td> </tr> <tr> <td>$\Phi > 0.30$</td> <td>0</td> <td>---</td> </tr> </tbody> </table> <p>3-3 Polarizer Bubble</p> <table border="1" data-bbox="434 1272 1283 1435"> <thead> <tr> <th>Dimension</th> <th>Acceptable number</th> <th>Mini. Space</th> </tr> </thead> <tbody> <tr> <td>$\Phi \leq 0.25$</td> <td>Ignore</td> <td>---</td> </tr> <tr> <td>$0.25 < \Phi \leq 0.35$</td> <td>3</td> <td>15 m m</td> </tr> <tr> <td>$\Phi > 0.35$</td> <td>0</td> <td>---</td> </tr> </tbody> </table> <p>Foreign Substances</p>  <p>$\Phi = (a+b)/2$</p>	Length	Width	Acceptable number	Mini. space	---	$W \leq 0.05$	Ignore	5 m m	$L \leq 3.0$	$0.05 < W \leq 0.08$	4	$L \leq 3.0$	$0.08 < W \leq 0.15$	3	--	$W > 0.15$	Not allowed	---	Dimension	Acceptable number	Mini. Space	$\Phi \leq 0.15$	Ignore	---	$0.15 < \Phi \leq 0.20$	3	5 m m	$0.20 < \Phi \leq 0.30$	2	$\Phi > 0.30$	0	---	Dimension	Acceptable number	Mini. Space	$\Phi \leq 0.25$	Ignore	---	$0.25 < \Phi \leq 0.35$	3	15 m m	$\Phi > 0.35$	0	---	
		Length	Width	Acceptable number	Mini. space																																										
		---	$W \leq 0.05$	Ignore	5 m m																																										
$L \leq 3.0$	$0.05 < W \leq 0.08$	4																																													
$L \leq 3.0$	$0.08 < W \leq 0.15$	3																																													
--	$W > 0.15$	Not allowed	---																																												
Dimension	Acceptable number	Mini. Space																																													
$\Phi \leq 0.15$	Ignore	---																																													
$0.15 < \Phi \leq 0.20$	3	5 m m																																													
$0.20 < \Phi \leq 0.30$	2																																														
$\Phi > 0.30$	0	---																																													
Dimension	Acceptable number	Mini. Space																																													
$\Phi \leq 0.25$	Ignore	---																																													
$0.25 < \Phi \leq 0.35$	3	15 m m																																													
$\Phi > 0.35$	0	---																																													



NO	Item	Acceptable specification	Judgment Criterion			
3	Cosmetic Inspection	3-4 Scratch ● Sensate scratch not allowed. ● Impassive scratch as below. Unit:mm				
		Length		Width	Acceptable number	Mini. space
		-----		$W \leq 0.05$	Ignore	5 m m
		$L \leq 3.0$		$0.05 < W \leq 0.08$	4	
		$L \leq 3.0$		$0.08 < W \leq 0.15$	3	---
		----		$0.15 < W$	Not allowed	
		$L > 3.0$		----	Not allowed	
4	Package	4-1 Mixed product types 4-2 Shipping q'ty should be the same as "shipping notice form" q'ty. 4-3 Outer box can't broken.	N=0			
5	LCD Mura	LCD Mura according to ND 5% keep out to determine, if keep out distance at 30cm be seen by eyes is NG, otherwise will be ok if invisible.				



7. RELIABILITY

Test Item	Test Condition
High Temperature Operation	60°C for 96 hours
Low Temperature Operation	-20°C for 96 hours
High Temperature Storage	70°C for 96 hours
Low Temperature Storage	-30°C for 96 hours
High Temperature Operation Humidity Operation	60°C, 90%RH for 72 hours
Thermal Shock	-10°C (30min) ~ +25°C (5min) ~ +60°C (30min) for 10 cycles
Vibration Test (No Operation)	Frequency: 10~55Hz Amplitude:1.0mm Sweep Time: 11min Test Period: 6 Cycles for each direction of X, Y, Z
Static electricity test	Touch 4KV, air touch 8KV



8. HANDLING PRECAUTION

8.1 SAFETY

- (1) Do not swallow any liquid crystal, even if there is no proof that liquid crystal is poisonous.
- (2) If the LCD panel breaks, be careful not to get liquid crystal to touch your skin.
- (3) If skin is exposed to liquid crystal, wash the area thoroughly with alcohol or soap.

8.2 STORAGE CONDITIONS

- (1) Store the panel or module in a dark place where the temperature is $23\pm 5^{\circ}\text{C}$ and the humidity is below $50\pm 20\%\text{RH}$.
- (2) Store in anti-static electricity container.
- (3) Store in clean environment, free from dust, active gas, and solvent.
- (4) Do not place the module near organics solvents or corrosive gases.
- (5) Do not crush, shake, or jolt the module.

8.3 HANDLING PRECAUTIONS

- (1) Avoid static electricity which can damage the CMOS LSI.
- (2) The polarizing plate of the display is very fragile. So, please handle it very carefully.
- (3) Do not give external shock.
- (4) Do not apply excessive force on the surface.
- (5) Do not wipe the polarizing plate with a dry cloth, as it may easily scratch the surface of plate.
- (6) Do not use ketonic solvent & Aromatic solvent, use with a soft cloth soaked with a cleaning naphtha solvent.
- (7) Do not operate it above the absolute maximum rating.
- (8) Do not remove the panel or frame from the module.

8.4 WARRANTY

- 1) The period is within twelve months since the date of shipping out under normal using and storage conditions.
- 2) According to KINGTECH TFT LCD quality standard, KINGTECH will rework or exchange for functional defect goods since within one year.



9. Packagingfigure

